



Engineered
and Certified
for AV over IP

Introducing the NETGEAR AV and IT M4350 Switches, engineered and certified for audio/video over IP with dedicated service and support. The M4350 brings all the simplicity from the M4250 AV Line packed in more Enterprise-class hardware with redundant power supplies and larger fabrics with 25G and 100G uplinks. The revolutionary NETGEAR AV user interface and Engage™ Controller contain pre-configured profiles for all major audio, video, and lighting protocols.

NETGEAR listens to and supports the Pro AV community

- IGMP Plus™ means AV-over-IP multicasting will work out of the box and not flood your network
- Auto-LAG and Auto-Trunk automatically configure the uplinks between multiple switches
- The Engage™ Controller manages all M4250, M4300, M4350, and M4500 switches for your AV installations
- NETGEAR Pro AV Design team to help with system design and implementation to ensure the project will work
- AVB, Dante, Q-SYS, AES67, NVX, AMX, IPMX, NDI 4/5/6, ZeeVee, Aurora Multimedia, Kramer, Atlona, LibAV, Visionary, SDVoE, and many others!
- SMPTE ST 2110 supported on select models, always with the same simplicity from the AV UI

Enterprise-class hardware

- From 1G to 2.5G, to 10G, to 25G, to 100G always within 40cm (15.7in) depth
- Controlled thermal and acoustics (intelligent fans configurable in Quiet Mode to minimize noise, or Cool Mode to minimize heat)

Other IT use cases

- Edge to core stackable platform, from 1 Gigabit to 100 Gigabit for midsize organizations
- Non-stop forwarding (NSF) provides advanced High Availability (HA) with hitless failover across the stack

Industry standard management

- Industry standard command line interface (CLI), main NETGEAR IT web interface (GUI)
- SNMP, sFlow and RSPAN - the entire feature set is available without license

Industry leading warranty

- NETGEAR M4350 series is covered under NETGEAR ProSAFE Limited Lifetime Hardware Warranty*
- 90 days of Technical Support via phone and email, Lifetime Technical Support through online chat and Lifetime Next Business Day hardware replacement



Hardware-at-a-Glance

			FRONT						REAR			MANAGEMENT		
Model Name	Form-Factor	Switching Fabric	1000BASE-T RJ45 ports	2.5GBASE-T RJ45 ports	10GBASE-T RJ45 ports	10GBASE-X SFP+ ports	25GBASE-X SFP28 ports	100GBASE-X QSFP28 ports	Internal PSU	Modular PSU Bays	Fans	Out-of-band Console	Model Number	
M4350-24G4XF	Full width 1U rack mount 440x43.2x400mm	128 Gbps	24 ports PoE+ 10M; 100M; 1G 648W (base) up to 720W	-	-	4 ports 1G; 10G	-	-	1 x Fixed 880W (C14) On/Off switch	1 slot	Fixed Front-to-back	Ethernet: Out-of-band 1G port (Back)	GSM4328	
M4350-48G4XF	Full width 1U rack mount 440x43.2x400mm	176 Gbps	48 ports PoE+ 10M; 100M; 1G 236W (base) up to 1,440W	-	-	4 ports 1G; 10G	-	-	1 x Fixed 550W (C14) On/Off switch	2 slots			GSM4352	
M4350-44M4X4V	Full width 1U rack mount 440x43.2x400mm	500 Gbps	-	44 ports PoE++*** 100M; 1G; 2.5G <--- 194W (base), up to 3,314W ---->	4 ports PoE++*** 1G; 2.5G; 5G; 10G	-	4 ports 10G; 25G (Ethernet Mode*) (Stacking: 25G**)	-	1 x Fixed 550W (C14) On/Off switch	2 slots			Console: USB-C (Front)	MSM4352
M4350-8X8F	Half-width 1- or 2-unit 1U rack mount 220x43.2x400mm	320 Gbps	-	-	8 ports 100M; 1G; 2.5G; 5G; 10G	8 ports 1G (ports 9-12 only); 10G	-	-	1 x Fixed 240W (C14) On/Off switch	-			Storage: 2 x USB-A (Back)	XSM4316
M4350-12X12F	Half-width 1- or 2-unit 1U rack mount 220x43.2x400mm	480 Gbps	-	-	12 ports 100M; 1G; 2.5G; 5G; 10G	12 ports 1G (ports 13-20 only); 10G	-	-	1 x Fixed 240W (C14) On/Off switch	-				XSM4324
M4350-24X4V	Full width 1U rack mount 440x43.2x400mm	680 Gbps	-	-	24 ports PoE+ 100M (ports 1-16 only); 1G; 2.5G; 5G; 10G 576W (base), up to 720W	-	4 ports 10G; 25G (Ethernet Mode*) (Stacking: 25G**)	-	1 x Fixed 880W (C14) On/Off switch	1 slot				XSM4328CV
M4350-24F4V	Full width 1U rack mount 440x43.2x400mm	680 Gbps	-	-	-	24 ports 1G (ports 1-16 only); 10G	4 ports 10G; 25G (Ethernet Mode*) (Stacking: 25G**)	-	1 x Fixed 240W (C14) On/Off switch	1 slot				XSM4328FV

* ETHERNET Mode: Each 4 x 25G block is connected to a 100G SERDES. As such, each 4-port block can only work at the same speed: 4x10G, or 4x25G. Since 25G takes precedence, when one 25G module is inserted, other ports with 10G modules get down in the same 4-port block.

** STACKING Mode: Stacking link only works on the highest speed supported by a Stack port. A 25G port, when configured in Stack mode, only operates at 25G. It cannot operate at 10G. Similarly, a 100G port, when configured in Stack mode, only operates at 100G.

*** Ultra90 PoE++ 802.3bt is compatible with 802.3af PoE (15.4W), 802.3at PoE+ (30W) and 802.3bt (60W, 75W and 90W).

Hardware-at-a-Glance

Model Name	Form-Factor	Switching Fabric	FRONT						REAR			MANAGEMENT	Model Number
			1000BASE-T RJ45 ports	2.5GBASE-T RJ45 ports	10GBASE-T RJ45 ports	10GBASE-X SFP+ ports	25GBASE-X SFP28 ports	100GBASE-X QSFP28 ports	Internal PSU	Modular PSU Bays	Fans	Out-of-band Console	
M4350-36X4V	Full width 1U rack mount 440x43.2x400mm	920 Gbps	-	-	36 ports PoE++*** 100M (ports 1-28 only); 1G; 2.5G; 5G; 10G 280W (base), up to 1,760W	-	4 ports 10G; 25G (Ethernet Mode*) (Stacking: 25G**)	-	1 x Fixed 750W (C14) On/Off switch	1 slot	Fixed Front-to-back	Ethernet: Out-of-band 1G port (Back)	XSM4340CV
M4350-24X8F8V	Full width 1U rack mount 440x43.2x400mm	1.04 Tbps	-	-	24 ports PoE++*** 100M; 1G; 2.5G; 5G; 10G 290W (base), up to 1,770W	8 ports 1G (ports 25-28 only); 10G	8 ports 10G; 25G (Ethernet Mode*) (Stacking: 25G**)	-	1 x Fixed 750W (C14) On/Off switch	1 slot			XSM4340V
M4350-32F8V	Full width 1U rack mount 440x43.2x400mm	1.04 Tbps	-	-	-	32 ports 1G (ports 1-28 only); 10G	8 ports 10G; 25G (Ethernet Mode*) (Stacking: 25G**)	1 x Fixed 420W (C14) On/Off switch	1 slot	XSM4340FV			
M4350-16V4C	Full width 1U rack mount 440x43.2x400mm	1.6 Tbps	-	-	-	-	16 ports 10G; 25G (Ethernet Mode*)	4 ports 40G; 100G (Stacking: 100G**)	1 x Fixed 420W (C14) On/Off switch	1 slot		Storage: 2 x USB-A (Back)	VSM4320C
M4350-40X4C	Full width 1U rack mount 440x43.2x400mm	1.6 Tbps	-	-	40 ports PoE++*** 1G; 2.5G; 5G; 10G 196W (base), up to 1,676W	-	-	4 ports 40G; 100G (Stacking: 100G**)	1 x Fixed 750W (C14) On/Off switch	1 slot		XSM4344C	

* ETHERNET Mode: Each 4 x 25G block is connected to a 100G SERDES. As such, each 4-port block can only work at the same speed: 4x10G, or 4x25G. Since 25G takes precedence, when one 25G module is inserted, other ports with 10G modules get down in the same 4-port block.

** STACKING Mode: Stacking link only works on the highest speed supported by a Stack port. A 25G port, when configured in Stack mode, only operates at 25G. It cannot operate at 10G. Similarly, a 100G port, when configured in Stack mode, only operates at 100G.

*** Ultra90 PoE++ 802.3bt is compatible with 802.3af PoE (15.4W), 802.3at PoE+ (30W) and 802.3bt (60W, 75W and 90W).

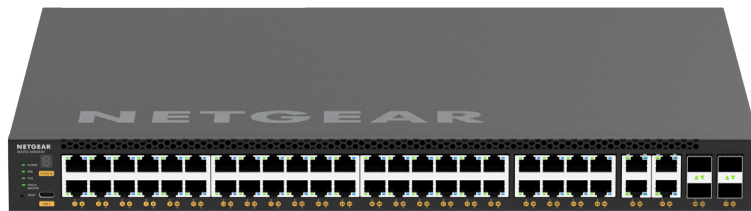

RPS+EPS Wattages*-at-a-Glance

Model Name	Internal PSU	Modular PSUs		Switch Operational Without PoE?	Available PoE Budget	Model Number
		PSU Slot 1	PSU Slot 2			
M4350-24G4XF	880W - Connected	Disconnected	-	Yes	648W	GSM4328
APS350W-100NES/AJS	880W - Connected	APS350W	-	Yes	720W	APS350W-100NES/AJS
APS350W-100NES/AJS	Disconnected	APS350W	-	Yes	218W	APS350W-100NES/AJS
APS600W-200NES/AJS	880W - Connected	APS600Wv2	-	Yes	720W	APS600W-200NES/AJS
APS600W-200NES/AJS	Disconnected	APS600Wv2	-	Yes	468W	APS600W-200NES/AJS
APS920W-100NES/AJS	880W - Connected	APS920W	-	Yes	720W	APS920W-100NES/AJS
APS920W-100NES/AJS	Disconnected	APS920W	-	Yes	720W	APS920W-100NES/AJS
APS2000W-100NES/AJS	880W - Connected	APS2000W 110VAC	-	Yes	720W	APS2000W-100NES/AJS
APS2000W-100NES/AJS	Disconnected	APS2000W 110VAC	-	Yes	720W	APS2000W-100NES/AJS
APS2000W-100NES/AJS	880W - Connected	APS2000W 220VAC	-	Yes	720W	APS2000W-100NES/AJS
APS2000W-100NES/AJS	Disconnected	APS2000W 220VAC	-	Yes	720W	APS2000W-100NES/AJS
M4350-48G4XF	550W - Connected	Disconnected	Disconnected	Yes	236W	GSM4352
APS350W-100NES/AJS	550W - Connected	APS350W	Disconnected	Yes	436W	APS350W-100NES/AJS
APS350W-100NES/AJS	Disconnected	APS350W	Disconnected	Yes	186W	APS350W-100NES/AJS
APS600W-200NES/AJS	550W - Connected	APS600Wv2	Disconnected	Yes	636W	APS600W-200NES/AJS
APS600W-200NES/AJS	Disconnected	APS600Wv2	Disconnected	Yes	436W	APS600W-200NES/AJS
APS920W-100NES/AJS	550W - Connected	APS920W	Disconnected	Yes	892W	APS920W-100NES/AJS
APS920W-100NES/AJS	Disconnected	APS920W	Disconnected	Yes	756W	APS920W-100NES/AJS
APS2000W-100NES/AJS	550W - Connected	APS2000W 110VAC	Disconnected	Yes	956W	APS2000W-100NES/AJS
APS2000W-100NES/AJS	Disconnected	APS2000W 110VAC	Disconnected	Yes	836W	APS2000W-100NES/AJS
APS2000W-100NES/AJS	550W - Connected	APS2000W 220VAC	Disconnected	Yes	1,440W	APS2000W-100NES/AJS
APS2000W-100NES/AJS	Disconnected	APS2000W 220VAC	Disconnected	Yes	1,440W	APS2000W-100NES/AJS
M4350-48G4XF	550W - Connected	Disconnected	Disconnected	Yes	236W	GSM4352
APS350W-100NES/AJS	550W - Connected	APS350W	APS350W	Yes	716W	APS350W-100NES/AJS
APS350W-100NES/AJS	Disconnected	APS350W	APS350W	Yes	396W	APS350W-100NES/AJS
APS600W-200NES/AJS	550W - Connected	APS600Wv2	APS600Wv2	Yes	1,116W	APS600W-200NES/AJS
APS600W-200NES/AJS	Disconnected	APS600Wv2	APS600Wv2	Yes	796W	APS600W-200NES/AJS
APS920W-100NES/AJS	550W - Connected	APS920W	APS920W	Yes	1,440W	APS920W-100NES/AJS
APS920W-100NES/AJS	Disconnected	APS920W	APS920W	Yes	1,308W	APS920W-100NES/AJS
APS2000W-100NES/AJS	550W - Connected	APS2000W 110VAC	APS2000W 110VAC	Yes	1,440W	APS2000W-100NES/AJS
APS2000W-100NES/AJS	Disconnected	APS2000W 110VAC	APS2000W 110VAC	Yes	1,436W	APS2000W-100NES/AJS
APS2000W-100NES/AJS	550W - Connected	APS2000W 220VAC	APS2000W 220VAC	Yes	1,440W	APS2000W-100NES/AJS
APS2000W-100NES/AJS	Disconnected	APS2000W 220VAC	APS2000W 220VAC	Yes	1,440W	APS2000W-100NES/AJS

RPS+EPS Wattages*-at-a-Glance

Model Name	Internal PSU	Modular PSUs		Switch Operational Without PoE?	Available PoE Budget	Model Number
		PSU Slot 1	PSU Slot 2			
M4350-44M4X4V	550W - Connected	Disconnected	Disconnected	Yes	194W	MSM4352
APS350W-100NES/AJS	550W - Connected	APS350W	Disconnected	Yes	394W	APS350W-100NES/AJS
APS350W-100NES/AJS	Disconnected	APS350W	Disconnected	Yes	144W	APS350W-100NES/AJS
APS600W-200NES/AJS	550W - Connected	APS600Wv2	Disconnected	Yes	594W	APS600W-200NES/AJS
APS600W-200NES/AJS	Disconnected	APS600Wv2	Disconnected	Yes	394W	APS600W-200NES/AJS
APS920W-100NES/AJS	550W - Connected	APS920W	Disconnected	Yes	850W	APS920W-100NES/AJS
APS920W-100NES/AJS	Disconnected	APS920W	Disconnected	Yes	714W	APS920W-100NES/AJS
APS2000W-100NES/AJS	550W - Connected	APS2000W 110VAC	Disconnected	Yes	914W	APS2000W-100NES/AJS
APS2000W-100NES/AJS	Disconnected	APS2000W 110VAC	Disconnected	Yes	794W	APS2000W-100NES/AJS
APS2000W-100NES/AJS	550W - Connected	APS2000W 220VAC	Disconnected	Yes	1,786W	APS2000W-100NES/AJS
APS2000W-100NES/AJS	Disconnected	APS2000W 220VAC	Disconnected	Yes	1,694W	APS2000W-100NES/AJS
M4350-44M4X4V	550W - Connected	Disconnected	Disconnected	Yes	194W	MSM4352
APS350W-100NES/AJS	550W - Connected	APS350W	APS350W	Yes	674W	APS350W-100NES/AJS
APS350W-100NES/AJS	Disconnected	APS350W	APS350W	Yes	354W	APS350W-100NES/AJS
APS600W-200NES/AJS	550W - Connected	APS600Wv2	APS600Wv2	Yes	1,074W	APS600W-200NES/AJS
APS600W-200NES/AJS	Disconnected	APS600Wv2	APS600Wv2	Yes	754W	APS600W-200NES/AJS
APS920W-100NES/AJS	550W - Connected	APS920W	APS920W	Yes	1,586W	APS920W-100NES/AJS
APS920W-100NES/AJS	Disconnected	APS920W	APS920W	Yes	1,266W	APS920W-100NES/AJS
APS2000W-100NES/AJS	550W - Connected	APS2000W 110VAC	APS2000W 110VAC	Yes	1,714W	APS2000W-100NES/AJS
APS2000W-100NES/AJS	Disconnected	APS2000W 110VAC	APS2000W 110VAC	Yes	1,394W	APS2000W-100NES/AJS
APS2000W-100NES/AJS	550W - Connected	APS2000W 220VAC	APS2000W 220VAC	Yes	3,314W	APS2000W-100NES/AJS
APS2000W-100NES/AJS	Disconnected	APS2000W 220VAC	APS2000W 220VAC	Yes	2,994W	APS2000W-100NES/AJS
M4350-24X4V	880W - Connected	Disconnected	-	Yes	576W	XSM4328CV
APS350W-100NES/AJS	880W - Connected	APS350W	-	Yes	700W	APS350W-100NES/AJS
APS350W-100NES/AJS	Disconnected	APS350W	-	Yes	146W	APS350W-100NES/AJS
APS600W-200NES/AJS	880W - Connected	APS600Wv2	-	Yes	720W	APS600W-200NES/AJS
APS600W-200NES/AJS	Disconnected	APS600Wv2	-	Yes	396W	APS600W-200NES/AJS
APS920W-100NES/AJS	880W - Connected	APS920W	-	Yes	720W	APS920W-100NES/AJS
APS920W-100NES/AJS	Disconnected	APS920W	-	Yes	716W	APS920W-100NES/AJS
APS2000W-100NES/AJS	880W - Connected	APS2000W 110VAC	-	Yes	720W	APS2000W-100NES/AJS
APS2000W-100NES/AJS	Disconnected	APS2000W 110VAC	-	Yes	720W	APS2000W-100NES/AJS
APS2000W-100NES/AJS	880W - Connected	APS2000W 220VAC	-	Yes	720W	APS2000W-100NES/AJS
APS2000W-100NES/AJS	Disconnected	APS2000W 220VAC	-	Yes	720W	APS2000W-100NES/AJS

RPS+EPS Wattages*-at-a-Glance

Model Name	Internal PSU	Modular PSUs		Switch Operational Without PoE?	Available PoE Budget	Model Number
		PSU Slot 1	PSU Slot 2			
M4350-24F4V	240W - Connected	Disconnected	-	Yes	-	XSM4328FV
APS350W-100NES/AJS	240W - Connected	APS350W	-	Yes	-	APS350W-100NES/AJS
APS350W-100NES/AJS	Disconnected	APS350W	-	Yes	-	APS350W-100NES/AJS
APS600W-200NES/AJS	240W - Connected	APS600Wv2	-	Yes	-	APS600W-200NES/AJS
APS600W-200NES/AJS	Disconnected	APS600Wv2	-	Yes	-	APS600W-200NES/AJS
APS920W-100NES/AJS	240W - Connected	APS920W	-	Yes	-	APS920W-100NES/AJS
APS920W-100NES/AJS	Disconnected	APS920W	-	Yes	-	APS920W-100NES/AJS
APS2000W-100NES/AJS	240W - Connected	APS2000W 110VAC	-	Yes	-	APS2000W-100NES/AJS
APS2000W-100NES/AJS	Disconnected	APS2000W 110VAC	-	Yes	-	APS2000W-100NES/AJS
APS2000W-100NES/AJS	240W - Connected	APS2000W 220VAC	-	Yes	-	APS2000W-100NES/AJS
APS2000W-100NES/AJS	Disconnected	APS2000W 220VAC	-	Yes	-	APS2000W-100NES/AJS
M4350-36X4V	750W - Connected	Disconnected	-	Yes	280W	XSM4340CV
APS600W-300NES/AJS	750W - Connected	APS600Wv3	-	Yes	640W	APS600W-300NES/AJS
APS600W-300NES/AJS	Disconnected	APS600Wv3	-	Yes	280W	APS600W-300NES/AJS
APS1200W-200NES/AJS	750W - Connected	APS1200Wv2 110VAC	-	Yes	960W	APS1200W-200NES/AJS
APS1200W-200NES/AJS	Disconnected	APS1200Wv2 110VAC	-	Yes	680W	APS1200W-200NES/AJS
APS1200W-200NES/AJS	750W - Connected	APS1200Wv2 220VAC	-	Yes	1,120W	APS1200W-200NES/AJS
APS1200W-200NES/AJS	Disconnected	APS1200Wv2 220VAC	-	Yes	880W	APS1200W-200NES/AJS
APS2000W-200NES/AJS	750W - Connected	APS2000Wv2 110VAC	-	Yes	960W	APS2000W-200NES/AJS
APS2000W-200NES/AJS	Disconnected	APS2000Wv2 110VAC	-	Yes	680W	APS2000W-200NES/AJS
APS2000W-200NES/AJS	750W - Connected	APS2000Wv2 220VAC	-	Yes	1,760W	APS2000W-200NES/AJS
APS2000W-200NES/AJS	Disconnected	APS2000Wv2 220VAC	-	Yes	1,680W	APS2000W-200NES/AJS
M4350-24X8F8V	750W - Connected	Disconnected	-	Yes	290W	XSM4340V
APS600W-300NES/AJS	750W - Connected	APS600Wv3	-	Yes	650W	APS600W-300NES/AJS
APS600W-300NES/AJS	Disconnected	APS600Wv3	-	Yes	290W	APS600W-300NES/AJS
APS1200W-200NES/AJS	750W - Connected	APS1200Wv2 110VAC	-	Yes	970W	APS1200W-200NES/AJS
APS1200W-200NES/AJS	Disconnected	APS1200Wv2 110VAC	-	Yes	690W	APS1200W-200NES/AJS
APS1200W-200NES/AJS	750W - Connected	APS1200Wv2 220VAC	-	Yes	1,130W	APS1200W-200NES/AJS
APS1200W-200NES/AJS	Disconnected	APS1200Wv2 220VAC	-	Yes	890W	APS1200W-200NES/AJS
APS2000W-200NES/AJS	750W - Connected	APS2000Wv2 110VAC	-	Yes	970W	APS2000W-200NES/AJS
APS2000W-200NES/AJS	Disconnected	APS2000Wv2 110VAC	-	Yes	690W	APS2000W-200NES/AJS
APS2000W-200NES/AJS	750W - Connected	APS2000Wv2 220VAC	-	Yes	1,770W	APS2000W-200NES/AJS
APS2000W-200NES/AJS	Disconnected	APS2000Wv2 220VAC	-	Yes	1,690W	APS2000W-200NES/AJS

* M4350 full width switches offer RPS (redundant power supply) and EPS (extended power supply) modes at the same time, automatically. This table explains the total PoE budget (EPS), and the protected PoE budget (RPS) for each combination of PSU.

RPS+EPS Wattages*-at-a-Glance

Model Name	Internal PSU	Modular PSUs		Switch Operational Without PoE?	Available PoE Budget	Model Number
		PSU Slot 1	PSU Slot 2			
M4350-32F8V	420W - Connected	Disconnected	-	Yes	-	XSM4340FV
APS600W-300NES/AJS	420W - Connected	APS600Wv3	-	Yes	-	APS600W-300NES/AJS
APS600W-300NES/AJS	Disconnected	APS600Wv3	-	Yes	-	APS600W-300NES/AJS
APS1200W-200NES/AJS	420W - Connected	APS1200Wv2 110VAC	-	Yes	-	APS1200W-200NES/AJS
APS1200W-200NES/AJS	Disconnected	APS1200Wv2 110VAC	-	Yes	-	APS1200W-200NES/AJS
APS1200W-200NES/AJS	420W - Connected	APS1200Wv2 220VAC	-	Yes	-	APS1200W-200NES/AJS
APS1200W-200NES/AJS	Disconnected	APS1200Wv2 220VAC	-	Yes	-	APS1200W-200NES/AJS
APS2000W-200NES/AJS	420W - Connected	APS2000Wv2 110VAC	-	Yes	-	APS2000W-200NES/AJS
APS2000W-200NES/AJS	Disconnected	APS2000Wv2 110VAC	-	Yes	-	APS2000W-200NES/AJS
APS2000W-200NES/AJS	420W - Connected	APS2000Wv2 220VAC	-	Yes	-	APS2000W-200NES/AJS
APS2000W-200NES/AJS	Disconnected	APS2000Wv2 220VAC	-	Yes	-	APS2000W-200NES/AJS
M4350-16V4C	420W - Connected	Disconnected	-	Yes	-	VSM4320C
APS600W-300NES/AJS	420W - Connected	APS600Wv3	-	Yes	-	APS600W-300NES/AJS
APS600W-300NES/AJS	Disconnected	APS600Wv3	-	Yes	-	APS600W-300NES/AJS
APS1200W-200NES/AJS	420W - Connected	APS1200Wv2 110VAC	-	Yes	-	APS1200W-200NES/AJS
APS1200W-200NES/AJS	Disconnected	APS1200Wv2 110VAC	-	Yes	-	APS1200W-200NES/AJS
APS1200W-200NES/AJS	420W - Connected	APS1200Wv2 220VAC	-	Yes	-	APS1200W-200NES/AJS
APS1200W-200NES/AJS	Disconnected	APS1200Wv2 220VAC	-	Yes	-	APS1200W-200NES/AJS
APS2000W-200NES/AJS	420W - Connected	APS2000Wv2 110VAC	-	Yes	-	APS2000W-200NES/AJS
APS2000W-200NES/AJS	Disconnected	APS2000Wv2 110VAC	-	Yes	-	APS2000W-200NES/AJS
APS2000W-200NES/AJS	420W - Connected	APS2000Wv2 220VAC	-	Yes	-	APS2000W-200NES/AJS
APS2000W-200NES/AJS	Disconnected	APS2000Wv2 220VAC	-	Yes	-	APS2000W-200NES/AJS
M4350-40X4C	750W - Connected	Disconnected	-	Yes	196W	XSM4344C
APS600W-300NES/AJS	750W - Connected	APS600Wv3	-	Yes	556W	APS600W-300NES/AJS
APS600W-300NES/AJS	Disconnected	APS600Wv3	-	Yes	196W	APS600W-300NES/AJS
APS1200W-200NES/AJS	750W - Connected	APS1200Wv2 110VAC	-	Yes	876W	APS1200W-200NES/AJS
APS1200W-200NES/AJS	Disconnected	APS1200Wv2 110VAC	-	Yes	596W	APS1200W-200NES/AJS
APS1200W-200NES/AJS	750W - Connected	APS1200Wv2 220VAC	-	Yes	1,036W	APS1200W-200NES/AJS
APS1200W-200NES/AJS	Disconnected	APS1200Wv2 220VAC	-	Yes	796W	APS1200W-200NES/AJS
APS2000W-200NES/AJS	750W - Connected	APS2000Wv2 110VAC	-	Yes	876W	APS2000W-200NES/AJS
APS2000W-200NES/AJS	Disconnected	APS2000Wv2 110VAC	-	Yes	596W	APS2000W-200NES/AJS
APS2000W-200NES/AJS	750W - Connected	APS2000Wv2 220VAC	-	Yes	1,676W	APS2000W-200NES/AJS
APS2000W-200NES/AJS	Disconnected	APS2000Wv2 220VAC	-	Yes	1,596W	APS2000W-200NES/AJS

* M4350 full width switches offer RPS (redundant power supply) and EPS (extended power supply) modes at the same time, automatically. This table explains the total PoE budget (EPS), and the protected PoE budget (RPS) for each combination of PSU.

Acoustic-at-a-Glance

Model Name	QUIET MODE Setting at ambient* (Default mode)					COOL MODE Setting at ambient*			
	PoE Power Load	Fan Duty	Ambient	Case Temp (Top)	Acoustic	Fan Duty	Case Temp (Top)	Acoustic	Model Number
M4350-24G4XF	720W	28	25°C	33.1°C	33dBA	60	31.9°C	52dBA	GSM4328
	720W	60	45°C	48.2°C	52dBA				
M4350-48G4XF	1,440W	28	25°C	33.4°C	33dBA	60	31.3°C	52dBA	GSM4352
	1,440W	60	45°C	48.5°C	52dBA				
M4350-44M4X4V	3,314W	28	25°C	43.3°C	34dBA	60	38.3°C	52dBA	MSM4352
	3,314W	60	45°C	50.1°C	52dBA				
M4350-8X8F	N/A	27	25°C	34.4°C	34.43dBA	70	30.3°C	56.3dBA	XSM4316
	N/A	70	50°C	51.7°C	56.3dBA				
M4350-12X12F	N/A	27	25°C	31.9°C	34.34dBA	100	29.5°C	64dBA	XSM4324
	N/A	100	50°C	51.5°C	64dBA				
M4350-24X4V	720W	30	25°C	32.3°C	34.7dBA	70	29.6°C	57.2dBA	XSM4328CV
	720W	70	45°C	46.6°C	57.2dBA				
M4350-24F4V	N/A	30	25°C	34.2°C	34.2dBA	85	30.3°C	61.8dBA	XSM4328FV
	N/A	85	50°C	52.4°C	61.8dBA				
M4350-36X4V	1760W	25	25°C	39°C	32.1dBA	60	30.4°C	54dBA	XSM4340CV
	1760W	60	45°C	49.2°C	54dBA				
M4350-24X8F8V	1770W	25	25°C	39.9°C	32.6dBA	60	31°C	53.3dBA	XSM4340V
	1770W	60	45°C	48.5°C	53.3dBA				
M4350-32F8V	N/A	25	25°C	35°C	32.7dBA	80	28.9°C	63dBA	XSM4340FV
	N/A	80	50°C	52.1°C	63dBA				
M4350-16V4C	N/A	28	25°C	38.2°C	36.4dBA	60	30.8°C	55dBA	VSM4320C
	N/A	60	45°C	56°C	55dBA				
M4350-40X4C	1676W	25	25°C	39.9°C	34.1dBA	60	33.9°C	54.3dBA	XSM4344C
	1676W	60	45°C	49.6°C	54.3dBA				

* dBA values are SPL (Sound Pressure Level) values, testing following the ISO-7779 standard. Bystander Mode. Chamber Temp 25°C during testing unless noted otherwise. Full, 100%, Data and PoE loaded. Worst case.
 For QUIET MODE, Min conditions are: Lowest fan duty when ambient temperature is 25°C, all ports used, max traffic, max PoE budget (additional PSUs). Worst case.
 For QUIET MODE, Max conditions are: Highest fan duty when ambient temperature is 45°C (PoE models) or 50°C (non-PoE models), all ports used, max traffic, max PoE budget (additional PSUs) (if applicable). Worst case.

Software-at-a-Glance

LAYER 3 PACKAGE*													
Model Name	Management	AV Dedicated UI	IPv4 / IPv6 ACL and QoS, DiffServ	IPv4 / IPv6 Multicast Filtering	SMTPE ST 2110	IPv4 / IPv6 Policing and Convergence	Spanning Tree Green Ethernet	VLANs	Trunking Port Channel	IPv4 / IPv6 Authentication Security	IPv4 / IPv6 Static Routing	IPv4 / IPv6 Dynamic Routing	Model Number
M4350 series	Out-of-band	AV Web-based GUI	Ingress/egress	NETGEAR IGMP™ Plus for automated IGMP between switches	Select models only	Auto-VoIP	STP, MTP, RSTP	Static, Dynamic, Voice, MAC	Auto-Trunk and Auto-LAG between M4250, M4300, and M4350 Switches	Successive Tiering (DOT1X; MAB; Captive Portal)	Port, Subnet, VLAN routing	IPv4: RIP, VRRP	All models
	IT Web GUI (main)	Designed for AV installers				LLDP-MED							
	Stacking** NSF with Hitless Failover	AV-related controls	1 Kbps shaping Time-based	IGMPv3 MLDv2 Snooping, Proxy ASM & SSM	IEEE 1588 PTPv2 1-Step End-to-End Transparent Clock (TC)	BPDU/STRG Root Guard	GVRP/GMRP	(LACP automatically reverts to and from Static LAG)	DHCP Snooping	DHCPv4 Server	DHCP Relay	Stateful DHCPv6 Server	
	SNMP, MIBs RSPAN	AVB profile	Single Rate Policing	IGMPv1,v2 Querier (compatible v3)	AVB: 802.1AS, 802.1Qav, 802.1Qat MSRP, 802.1ak MMRP, 802.1ak MVRP	EEE 802.3az (EEE is disabled by default)	Double VLAN mode	Private VLANs	Seven (7) L2/L3/L4 hashing algorithm	Dynamic ARP Inspection	DHCP Relay		
M4350-16V4C M4350-40X4C		ST 2110 profiles			Boundary Clock mode (BC) Grandmaster Clock mode (GM) PTP profiles for: SMPTE 2059-2 (video/audio), AES67 (Audio), AES-R16-2016 (Interoperability) Single-step/two-step PTP to the Grand-Master and the AV end-points								VSM4320C XSM4344C

* All software features are available, license-free.

** Stacking, AVB, and PTP TC are mutually exclusive features. A stack cannot run AVB, nor PTP TC (or BC/GM)



Performance-at-a-Glance

TABLE SIZE													
Model Name	MAC ARP/NDP	Routing / Switching Capacity	Throughput 64-byte	Application Route Scaling	Packet Buffer	Latency 64-byte	CPU	IP Multicast Routing Entries	Jumbo Frames	Multicast IGMP Group Membership	VLANs	DHCP	Model Number
M4350-24G4XF	16K MAC 4K ARP/ 512 NDP	128 Gbps Line-Rate	95.23 Mpps	Static: 256v4/64v6 RIP: 512 OSPF: 1,024	16Mb	<2.42µs 1G <0.92µs 10G fiber	Quad-Core Cortex-A57 ARMv8 1.8Ghz 64-bit 2GB RAM DDR4	512 IPv4 256 IPv6	Up to 12K	2K IPv4 2K IPv6	4K VLANs	DHCP Server: 2K leases IPv4: 256 pools IPv6: 16 pools	GSM4328
M4350-48G4XF	16K MAC 4K ARP/ 512 NDP	176 Gbps Line-Rate	130.94 Mpps		32Mb	<2.20µs 1G <0.70µs 10G fiber							GSM4352
M4350-44M4X4V	16K MAC 4K ARP/ 512 NDP	500 Gbps Line-Rate	372 Mpps		32Mb	<5.61µs 2.5G <2.27µs 10G copper <0.75µs 25G							MSM4352
M4350-8X8F	16K MAC 4K ARP/ 512 NDP	320 Gbps Line-Rate	238.08 Mpps		32Mb	<2.28µs 1G <2.39µs 10G copper <0.83µs 10G fiber							XSM4316
M4350-12X12F	16K MAC 4K ARP/ 512 NDP	480 Gbps Line-Rate	357.12 Mpps		32Mb	<2.14µs 1G <2.29µs 10G copper <0.72µs 10G fiber							XSM4324
M4350-24X4V	16K MAC 4K ARP/ 512 NDP	680 Gbps Line-Rate	505.92 Mpps		32Mb	<2.43µs 1G <2.20µs 10G copper <0.97µs 25G							XSM4328CV
M4350-24F4V	16K MAC 4K ARP/ 512 NDP	680 Gbps Line-Rate	505.92 Mpps		32Mb	<1.06µs 1G <0.63µs 10G fiber <0.67µs 25G							XSM4328FV
M4350-36X4V	16K MAC 4K ARP/ 512 NDP	920 Gbps Line-Rate	684.48 Mpps		64Mb	<2.54µs 1G <2.75µs 10G copper <1.08µs 25G							XSM4340CV
M4350-24X8F8V	16K MAC 4K ARP/ 512 NDP	1.04 Tbps Line-Rate	773.76 Mpps		64Mb	<2.7µs 10G copper <1.27µs 10G fiber <1.09µs 25G							XSM4340V
M4350-32F8V	16K MAC 4K ARP/ 512 NDP	1.04 Tbps Line-Rate	773.76 Mpps		64Mb	<1.27µs 10G fiber <1.08µs 25G							XSM4340FV
M4350-16V4C	16K MAC 4K ARP/ 512 NDP	1.6 Tbps Line-Rate	1190.4 Mpps	256Mb	<2.71µs 10G fiber <1.08µs 25G <1.13µs 100G	VSM4320C							
M4350-40X4C	16K MAC 4K ARP/ 512 NDP	1.6 Tbps Line-Rate	1190.4 Mpps	256Mb	<2.71µs 10G copper <1.08µs 25G fiber <1.04µs 100G	XSM4344C							

M4350 Series Features



The NETGEAR M4350 series is a versatile 1G, 2.5G, 10G, 25G, and 100G solution designed for the edge, the server room, and the core. M4350 delivers nonstop forwarding stacking, spine and leaf, edge to core connectivity for AV and IT networks. In AV environments, the AV User Interface, Engage Controller and AV profiles are certified by 200+ AV manufacturers.

NETGEAR M4350 series key features:

- Ranges from 1G to 100G with a variety of PoE+ and Ultra90 PoE++ options for 15.4W, 30W, 60W, 75W and 90W AVoIP endpoints
- Non-stop forwarding (NSF) provides advanced High Availability (HA) with hitless failover across the stack
- Entire feature set (L2 switching, L3 dynamic routing, time sensitive networking, AVB) available without license
- Low acoustics, half-width 16-port and 24-port 10G models can be paired in a single rack space for redundant Top of Rack
- For the IT team, only one platform from the edge to the core, one software to standardize on
- Redundant modular power supplies contribute to business continuity management
- Layer 3 feature set includes static and policy-based routing, RIP, VRRP, OSPF, and PIM dynamic routing

- No need for tradeoffs anymore between performance, reliability, HA, features, scale, futureproofing, complexity, or cost
- Front to back cooling, always within 40cm (15.7in) depth and controlled thermal and acoustics
- Intelligent fans configurable in Quiet Mode to minimize noise, or Cool Mode to minimize heat

NETGEAR M4350 series AV software features:

- Designed for the most demanding AV over IP installations of up to thousands of endpoints
- AV-centric User Interface allows for simple, profile-based, per-port configuration in a snap
- Works out of the box with automatic, multi-switch configuration for most AV-over-IP installs
- All the simplicity of the M4250 AV Line packed in more Enterprise-class hardware with redundant power supplies and larger fabrics with 25G and 100G uplinks

M4350 Series Features

- Less time to install and configure using the NETGEAR Engage™ Controller
- SMPTE ST 2110 supported on select models, always with the same simplicity from the AV UI
- NETGEAR IGMP Plus™ means AV-over-IP multicasting will work out of the box and not flood your network
- With Auto-Trunk and Auto-LAG, simply connect M4350 switches together and you are done!

NETGEAR M4350 series other software features:

- Static, RIP and PIM-SM, DM and SSM multicast routing, DHCP Server and PTPv2 Transparent Clock (1-step E2E)
- Advanced classifier-based, time-based hardware implementation for L2 (MAC), L3 (IP) and L4 (UDP/TCP transport ports) security and prioritization
- Selectable Port-Channel / LAG (802.3ad - 802.1AX) L2/L3/L4 hashing for fault tolerance and load sharing with any type of Ethernet channeling
- Voice VLAN with SIP, H323 and SCCP protocols detection and LLDP-MED IP phones automatic QoS and VLAN configuration
- Efficient authentication tiering with successive DOT1X, MAB and Captive Portal methods for streamlined BYOD
- Advanced IPv4/IPv6 security implementation including malicious code detection, DHCP Snooping, IP Source Guard protection and DoS attacks mitigation

NETGEAR M4350 series management features:

- DHCP/BootP innovative auto-installation including firmware and configuration file upload automation
- Industry standard SNMP, RMON, MIB, LLDP, AAA, sFlow, RSPAN and PTPv2

- Service port for out-of-band Ethernet management (OOB)
- USB Type-C port for local management console (unique NETGEAR driver for M4250/M4350)
- Standard USB-A ports for local storage, logs, configuration or image files
- Industry standard command line interface (CLI) for IT admins used to other vendors commands
- Fully functional Web console (main GUI) for IT admins who prefer an easy to use graphical interface
- Dedicated AV web-based GUI interface for AV installations

NETGEAR M4350 series warranty and support:

- NETGEAR ProSAFE Limited Lifetime Hardware Warranty**
- Included Lifetime Technical Support
- Included Lifetime Next Business Day Hardware Replacement
- Offering free network design services and installation support, the NETGEAR Engineering Services Team is ready to help ensure your 1G deployments with the M4350 switches go as smooth as possible. Just drop us an email at ProAVDesign@netgear.com to get started!



Features Highlights

Dedicated AV UI for AV installations

M4350 switch series is pre-configured for Audio and Video over IP out of the box with a dedicated AV web-based GUI interface for more specific AV installations

- Color-based AV profiles can be applied to the different ports
- The Engage™ Controller manages all M4250, M4300, and M4350 switches for your AV installations
- AVB, Dante, Q-SYS, AES67, NVX, AMX, Q-SYS, NDI 4, NDI 5, ZeeVee, Aurora Multimedia, Kramer, Atlona, LibAV, Visionary, SDVoE, and many others!
- Audio / video / control mixed profiles, and dedicated Lighting (Art-Net, sACN, etc.) VLAN/Profiles

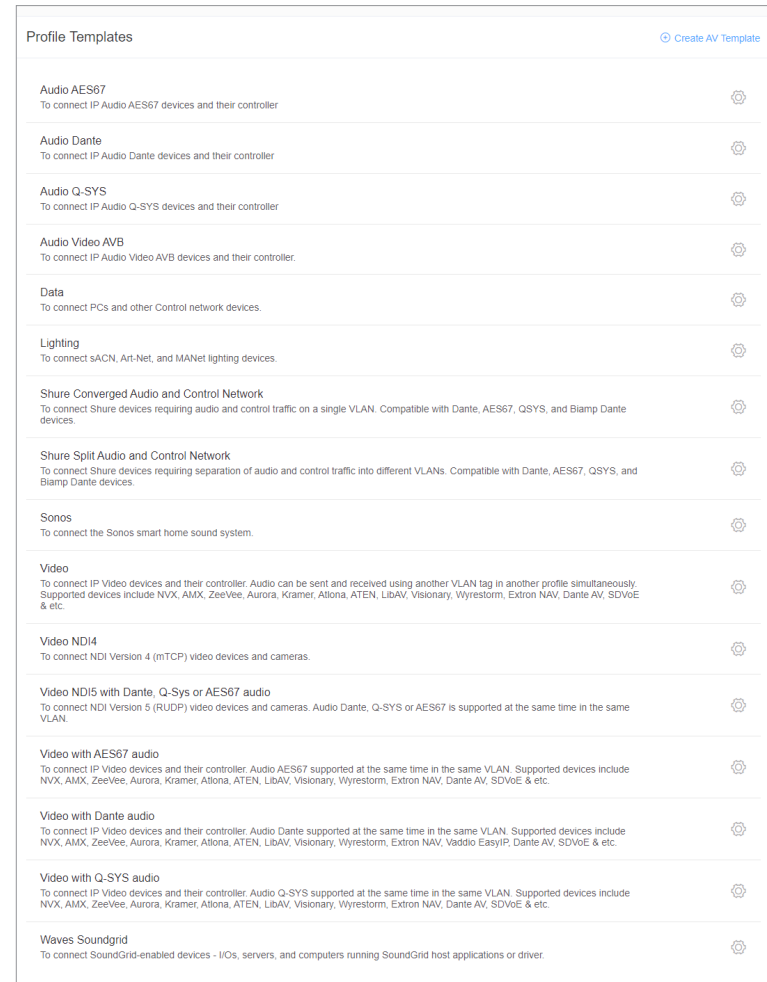
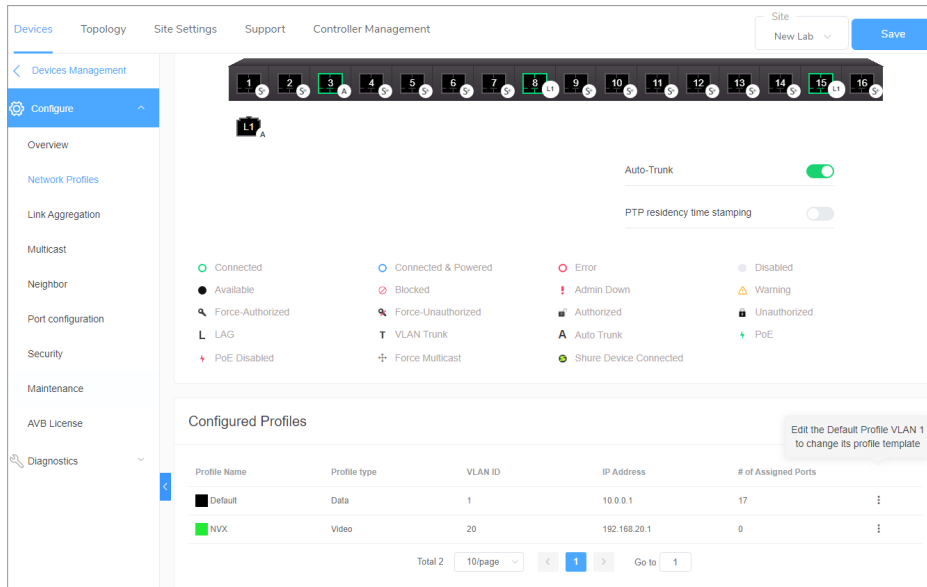

Features Highlights

High Density Layer 2 / Layer 3 / Layer 4 Stackable Switch Solution

M4350 switch series supports Nonstop Forwarding (NSF) virtual chassis stacking with up to 8 switches in a single logical switch, with hitless management failover

- Any 100G, 25G or 10G port and any media type can be used for stacking on any M4350 models
- Hot-swappable stacking of up to 8 units, vertical or horizontal
- Stacking link only works on the highest speed supported by a Stack port
- A 25G port, when configured in Stack mode, only operates at 25G - it cannot operate at 10G
- Similarly, a 100G port, when configured in Stack mode, only operates at 100G
- Stacking, AVB, and PTP TC are mutually exclusive features. A stack cannot run AVB, nor PTP TC (or BC/GM)
- L2, L3 and L4 switching features (access control list, classification, filtering, IPv4/IPv6 routing, IPv6 transition services) are performed in hardware at interface line rate for voice, video, and data convergence

M4350 series Layer 3 software package provides advanced IPv4/IPv6 fault tolerant routing capabilities for interfaces, VLANs, subnets, and multicast

Supported Stacking Topology for AV Applications

For AV, only 2-switch stacks are supported, because all the multicast is "replicated" in between the two switches

A redundant core in active/active mode is the main application, provided stacking, AVB, and PTP TC are mutually exclusive features

Main restriction: A stack cannot run AVB, nor PTP TC (or BC/GM)

Each M4350 model connects to the core using distributed link aggregation (LACP, fully automatic with Auto-LAG and Auto-Trunk)

In case of one core switch failure, there is no service interruption

(AV) 2-Switch stacking topology at the core

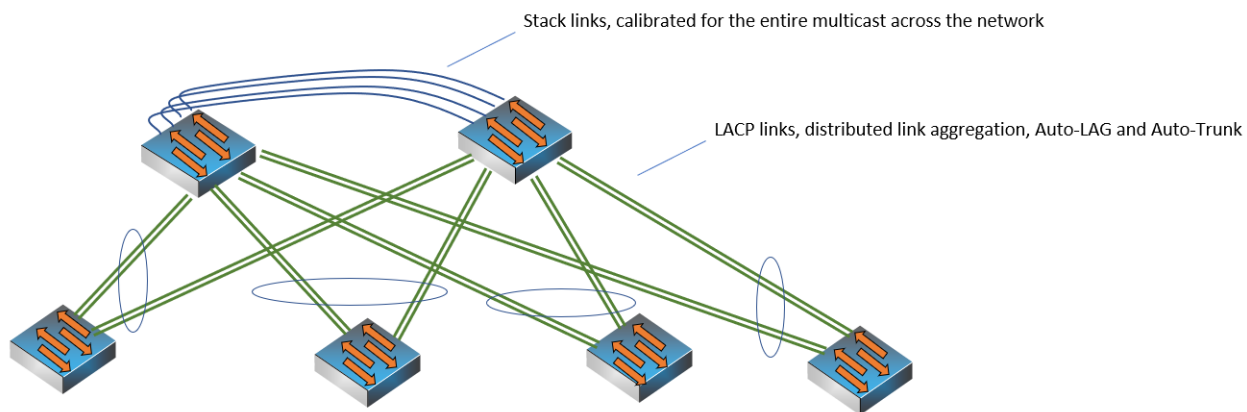

"Core" models: up to (16) 100G, 25G, or 10G ports per switch can be used for stacking (depending on total multicast requirement in the network)

Features Highlights

Supported Stacking Topologies for IT Applications

For IT, 8-switch stacks can be supported, but only at the edge (access layer)

At the core, only two M4350 switches can be stacked. For maximum performance, and best reliability, two switches should be the limit

(IT) Single or Dual Ring stacking topology
Core: 2-switch stack only

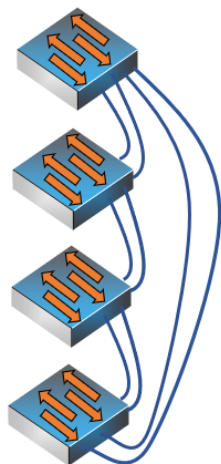

1G models: up to (4) 10G ports per switch can be used for stacking
(depending on inter-switch links oversubscription requirements)

(IT) "Double Star" stacking topology (edge only):

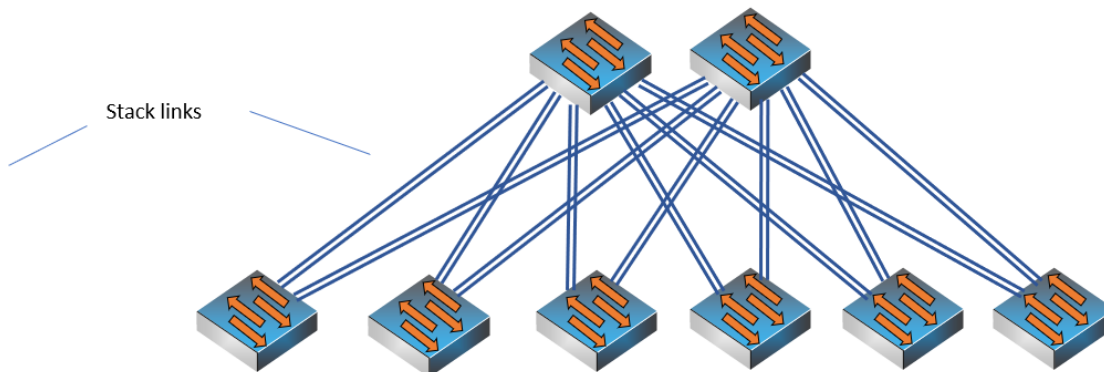

Other models: up to (16) 100G, 25G, or 10G ports per switch can be used for stacking
(again, depending on oversubscription requirements between switches)

Best value switching performance

16K MAC address table, 4K ARP and 4K concurrent VLANs for typical midsize environments

Low latency at all network speeds, including 10/25/100 Gigabit fiber interfaces

Jumbo frames support of up to 12KB accelerating performance with compatible nodes

Variety of PoE+ and Ultra90 PoE++ 802.3bt options for 15.4W, 30W, 60W, 75W and 90W endpoints, even on 10GBASE-T ports

All models come with an internal power supply for rapid deployment and lowest acoustic noise

Full width models come with one, or two additional PSU bays: extra PSU (sold separately) will add 1+1 power redundancy, as well as EPS (power sharing)

Controlled thermal and acoustics (intelligent fans configurable in Quiet Mode to minimize noise, or Cool Mode to minimize heat)

In default Quiet Mode, all models offer their max PoE budget always in the low 30's dBA when 25°C ambient (linear fan duty)

Features Highlights

Tier 1 availability

Virtual Chassis Stacking technology upsurges overall network availability, providing both better resiliency in network architectures, and better performance with advanced load balancing capabilities between network uplinks

- When at the core, up to (2) M4350 switches can be aggregated using a virtual backplane and a single console or web management interface
- When at the edge, up to (8) M4350 switches can be stacked in dual ring or double star topologies
- There is no 10G, 25G, or 100G port pre-configured as Stack port: all I/O ports are configured in Ethernet mode by default
 - Port configuration can be changed to Stack mode in Web GUI (System/ Stacking / Advanced / Stack-port Configuration)
 - Or using CLI command << #stack-port unit/slot/port stack >> in Stack Global Configuration section
- Other devices in the network see the stack as a single bridge or a single router
- Within the stack, a switch is elected (or chosen based on priority settings) as the “management unit” responsible for the stack members’ routing tables
- Another switch is designated (or chosen based on priority settings) as an alternate, backup management unit
- In typical spine and leaf architectures, 10/25/100G “spine” switches are meant to handle management unit and backup management unit roles
- The Non-Stop Forwarding (NSF) feature enables the stack to secure forwarding end-user traffic when the management unit fails
- Non-Stop Forwarding is supported for the following events:
 - Power failure of the management unit
 - Other hardware failure causing the management unit to hang or to reset
 - Software failure causing the management unit to hang or to reset
 - Failover initiated by the administrator
 - Loss of cascade connectivity between the management unit and the backup unit
- As the backup management unit takes over, end-user data streams may lose a few packets, but do not lose their IP sessions, such as VoIP calls
- Instant failover from management unit to redundant management unit is hitless for world-class resiliency and availability
- Back to normal production conditions, hitless failback requires a command in CLI or in GUI, for more control

Adding a second PSU to full width models enables redundant 1+1 power protection and contributes to business continuity management

Distributed Link Aggregation, also called Port Channeling or Port Trunking, offers powerful network redundancy and load balancing between stacked members

- Servers and other network devices benefit from greater bandwidth capacity with active-active teaming (LACP—link aggregation control protocol)
- From a system perspective, a LAG (Link Aggregation Group) is treated as a physical port by M4350 stack for even more simplicity

Rapid Spanning Tree (RSTP) and Multiple Spanning Tree (MSTP) allow for rapid transitioning of the ports to the Forwarding state and the suppression

NETGEAR PVSTP implementation follows the same rules than other vendor’s Per VLAN STP for strict interoperability

- Including industry-standard PVST+ interoperability
- PVSTP is similar to the MSTP protocol as defined by IEEE 802.1s, the main difference being PVSTP runs one instance per VLAN
- In other words, each configured VLAN runs an independent instance of PVSTP
- FastUplink feature immediately moves an alternate port with lowest cost to forwarding state when the root port goes down to reduce recovery time
- FastBackbone feature selects new indirect port when an indirect port fails

Features Highlights

NETGEAR PVRSTP implementation follows the same rules than other vendor's Per VLAN RSTP for strict interoperability

- Including industry-standard RPVST+ interoperability
- PVRSTP is similar to the RSTP protocol as defined by IEEE 802.1w, the main difference being PVRSTP runs one instance per VLAN
- In other words, each configured VLAN runs an independent instance of PVRSTP
- Each PVRSTP instance elects a root bridge independent of the other
- Hence there are as many Root Bridges in the region as there are VLANs configured
- Per VLAN RSTP has in built support for FastUplink and FastBackbone

IP address conflict detection performed by embedded DHCP servers prevents accidental IP address duplicates from perturbing the overall network stability

IP Event Dampening reduces the effect of interface flaps on routing protocols: the routing protocols temporarily disable their processing (on the unstable interface) until the interface becomes stable, thereby greatly increasing the overall stability of the network

Ease of deployment

Automatic configuration with DHCP and BootP Auto Install eases large deployments with a scalable configuration files management capability, mapping IP addresses and host names and providing individual configuration files to multiple switches as soon as they are initialized on the network

Both the Switch Serial Number and primary MAC address are reported by a simple "show hardware" command in CLI - facilitating discovery and remote configuration operations

M4350 DHCP L2 Relay agents eliminate the need to have a DHCP server on each physical network or subnet

- DHCP Relay agents process DHCP messages and generate new DHCP messages
- Supports DHCP Relay Option 82 circuit-id and remote-id for VLANs
- DHCP Relay agents are typically IP routing-aware devices and can be referred to as Layer 3 relay agents

Automatic Voice over IP prioritization with Auto-VoIP simplifies most complex multi-vendor IP telephones deployments either based on protocols (SIP, H323 and SCCP) or on OUI bytes (default database and user-based OUIs) in the phone source MAC address; providing the best class of service to VoIP streams (both data and signaling) over other ordinary traffic by classifying traffic, and enabling correct egress queue configuration

An associated Voice VLAN can be easily configured with Auto-VoIP for further traffic isolation

When deployed IP phones are LLDP-MED compliant, the Voice VLAN will use LLDP-MED to pass on the VLAN ID, 802.1P priority and DSCP values to the IP phones, accelerating convergent deployments

Ease of management and granular control

Dual firmware image and dual configuration file for transparent firmware updates / configuration changes with minimum service interruption

Flexible Port-Channel / LAG (802.3ad - 802.1AX) implementation for maximum compatibility, fault tolerance and load sharing with any type of Ethernet channeling from other vendors switch, server or storage devices conforming to IEEE 802.3ad - including static (selectable hashing algorithms) -or to IEEE 802.1AX with dynamic LAGs or port-channel (highly tunable LACP Link Aggregation Control Protocol)

LACP mode automatically reverts to and from Static LAG, useful when the host isn't LACP anymore, for instance during a factory reset or re-configuration

Auto-LAG: If more than one link between two M4350 switches, a Link Aggregation Group is created, dynamically

Unidirectional Link Detection Protocol (UDLD) and Aggressive UDLD detect and avoid unidirectional links automatically, in order to prevent forwarding anomalies in a Layer 2 communication channel in which a bi-directional link stops passing traffic in one direction

Port names feature allows for descriptive names on all interfaces and better clarity in real word admin daily tasks

Features Highlights

SDM (System Data Management, or switch database) templates allow for granular system resources distribution depending on IPv4 or IPv6 applications

- ARP Entries (the maximum number of entries in the IPv4 Address Resolution Protocol ARP cache for routing interfaces)
- IPv4 Unicast Routes (the maximum number of IPv4 unicast forwarding table entries)
- IPv6 NDP Entries (the maximum number of IPv6 Neighbor Discovery Protocol NDP cache entries)
- IPv6 Unicast Routes (the maximum number of IPv6 unicast forwarding table entries)
- ECMP Next Hops (the maximum number of next hops that can be installed in the IPv4 and IPv6 unicast forwarding tables)
- IPv4 Multicast Routes (the maximum number of IPv4 multicast forwarding table entries)
- IPv6 Multicast Routes (the maximum number of IPv6 multicast forwarding table entries)

Loopback interfaces management for routing protocols administration

Private VLANs and local Proxy ARP help reduce broadcast with added security

Management VLAN ID is user selectable for best convenience

Auto-Trunk: Dynamic VLAN trunking as soon as a M4250 switch gets connected to another M4250 switch

Industry-standard VLAN management in the command line interface (CLI) for all common operations such as VLAN creation; VLAN names; VLAN "make static" for dynamically created VLAN by GVRP registration; VLAN trunking; VLAN participation as well as VLAN ID (PVID) and VLAN tagging for one interface, a group of interfaces or all interfaces at once

Simplified VLAN configuration with industry-standard Access Ports for 802.1Q unaware endpoints and Trunk Ports for switch-to-switch links with Native VLAN

System defaults automatically set per-port broadcast, multicast, and unicast storm control for typical, robust protection against DoS attacks and faulty clients which can, with BYOD, often create network and performance issues

IP Telephony administration is simplified with consistent Voice VLAN capabilities per the industry standards and automatic functions associated

Comprehensive set of "system utilities" and "Clear" commands help troubleshoot connectivity issues and restore various configurations to their factory defaults for maximum admin efficiency: traceroute (to discover the routes that packets actually take when traveling on a hop-by-hop basis and with a synchronous response when initiated from the CLI), clear dynamically learned MAC addresses, counters, IGMP snooping table entries from the Multicast forwarding database etc...

Syslog and Packet Captures can be sent to USB storage for rapid network troubleshooting

Replaceable factory-default configuration file for predictable network reset in distributed branch offices without IT personnel

All major centralized software distribution platforms are supported for central software upgrades and configuration files management (HTTP, TFTP), including in highly secured versions (HTTPS, SFTP, SCP)

Simple Network Time Protocol (SNTP) can be used to synchronize network resources and for adaptation of NTP, and can provide synchronized network timestamp either in broadcast or unicast mode (SNTP client implemented over UDP - port 123)

Embedded RMON (4 groups) and sFlow agents permit external network traffic analysis

Engineered for convergence and AV-over-IP

Audio (Voice over IP) and Video (multicasting) comprehensive switching, filtering, routing and prioritization

Auto-VoIP, Voice VLAN and LLDP-MED support for IP phones QoS and VLAN configuration

IEEE 1588 (section 10 and 11.5) PTPv2 Transparent Clock (TC) End-to-End implementation considering the residence time of PTPv2 packets from ingress to egress

- 1-step Transparent Clock mode, using the residence time of the PTPv2 packet at the egress port level in Standalone mode, or Stack Master only
- The "Sync" & "Delay_Req" fields of passing/egressing out PTPv2 packets are updated with the residence time in the switch, the other fields in PTPv2 packets ("Announce", "Delay_Resp", "Pdelay_Req" and "Pdelay_Resp") are not updated
- Transparent Clock mode is not supported in a stack

Features Highlights

NETGEAR IGMP Plus™ for automatic multicast across a M4250 / M4300 / M4350/ M4500 L2 network (Spine and Leaf topologies), removing the need for L3 PIM routing

- IGMP Plus is pre-configured on default VLAN 1 out of the box
- IGMP Plus can be configured on another VLAN for automatic IGMP across switches on that VLAN (uplinks can make part of that VLAN in trunk mode)
- IGMP Plus allow AV-over-IP devices (TX/Encoders and RX/Decoders) to be connected across multiple switches in a star topology
- The show igmpsnooping group command in CLI and GUI displays the Source and Group IP addresses along with their corresponding MAC addresses that are learnt through IGMP Snooping in a given VLAN on a given interface

The M4350 series automatically configure the interconnect between switches for robust topologies

With IGMP Plus, Auto-Trunk and Auto-LAG, your deployment will JUST WORK

IGMP Snooping and Proxy for IPv4, MLD Snooping and Proxy for IPv6, and Querier mode facilitate fast receivers joins and leaves for multicast streams and ensure multicast traffic only reaches interested receivers everywhere in a Layer 2 or a Layer 3 network, including source-specific (SSM) and any-source (ASM) multicast

Multicast VLAN Registration (MVR) uses a dedicated Multicast VLAN to forward multicast streams and avoid duplication for clients in different VLANs

Distance Vector Multicast Routing Protocol (DVMRP) is a dense mode multicast protocol also called Broadcast and Prune Multicasting protocol

- DVMRP uses a distributed routing algorithm to build per-source-group multicast trees
- DVMRP assumes that all hosts are part of a multicast group until it is informed of multicast group changes
- It dynamically generates per-source-group multicast trees using Reverse Path Multicasting
- Trees are calculated and updated dynamically to track membership of individual groups

Multicast routing (PIM-SM and PIM-DM, both IPv4 and IPv6) ensure multicast streams can reach receivers in different L3 subnets

- Multicast static routes allowed in Reverse Path Forwarding (RPF) selection
- Multicast dynamic routing (PIM associated with OSPF) including PIM multi-hop RP support for routing around damage advanced capabilities
- Full support of PIM (S,G,Rpt) state machine events as described in RFC 4601
- Improved Multicast PIM timer accuracy with hardware abstraction layer (HAPI) polling hit status for multicast entries in real time (without caching)

PoE power management and schedule enablement for powering on and powering off PoE nodes connected to the switch

AVB is one of the many features designed into the M4350 product line without any license

- IEEE 802.1BA-2011 Audio Video Bridging (AVB), IEEE 802.1AS-2011 gPTP, IEEE 802.1Qav-2009 FQTTSS, IEEE 802.1Qat-2010 MSRP, IEEE 802.1ak MMRP, IEEE 802.1ak MVRP
- Maximum of 500 AVB streams per switch
- AVB is not supported in LAG (link aggregation groups, or Etherchannel)
- AVB is not supported in a stack

Engineered for broadcast and studios

M4350-16V4C (VSM4320C) and M4350-40X4C (XSM4344C) only

SMPTE ST 2110 is supported on these 2 models equipped with a chipset capable of PTP boundary and PTP grandmaster clock modes in hardware

These two M4350 models offer the Boundary Clock mode (BC), as well as the Grandmaster Clock mode (GM)

Single-step or two-step PTP supported to the GrandMaster and the AV endpoints

Features Highlights

Only one PTP profile supported at a time on one switch, amongst:

- SMPTE 2059-2 PTP profile (video/audio)
 - AES67 PTP profile (audio)
 - AES-R16-2016 proposing interoperability between the first profiles (interoperability between IEEE1588v2, AES67 and SMPTE 2059-2)
- On M4350, PTP operates in multicast mode
- In multicast mode, all messages between the grandmaster and slaves use multicast

Time precision or time accuracy of the client compared to the master: +/- 500 nanoseconds of cumulated offset between the grand master and the endpoint

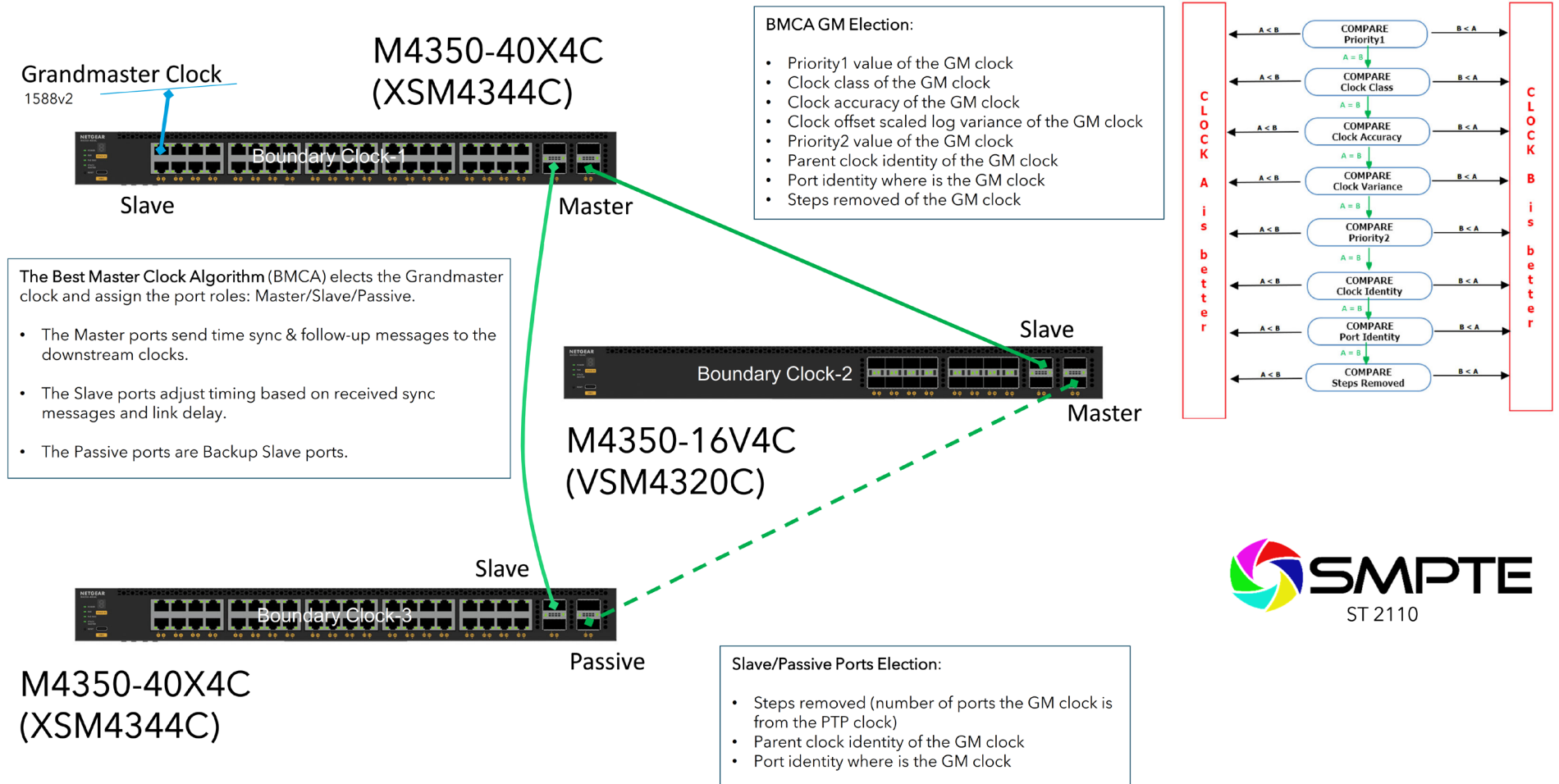

Features Highlights

Layer 3 routing package

Static Routes/ECMP Static Routes for IPv4 and IPv6

- Static and default routes are configurable with next IP address hops to any given destination
- Permitting additional routes creates several options for the network administrator
- The admin can configure multiple next hops to a given destination, intending for the router to load share across the next hops
- The admin distinguishes static routes by specifying a route preference value: a lower preference value is a more preferred static route
- A less preferred static route is used if the more preferred static route is unusable (down link, or next hop cannot be resolved to a MAC address)

Advanced Static Routing functions for administrative traffic control

- Static Reject Routes are configurable to control the traffic destined to a particular network so that it is not forwarded through the router
- Such traffic is discarded and the ICMP destination unreachable message is sent back to the source
- Static reject routes can be typically used to prevent routing loops
- Default routes are configurable as a preference option
- Preference option allows admin to control the preference of individual static routes relative to routes learned from other sources (such as OSPF) since a static route will be preferred over a dynamic route when routes from different sources have the same preference

In order to facilitate VLAN creation and VLAN routing using Web GUI, a VLAN Routing Wizard offers following automated capabilities:

- Create a VLAN and generate a unique name for VLAN
- Add selected ports to the newly created VLAN and remove selected ports from the default VLAN
- Create a LAG, add selected ports to a LAG, then add this LAG to the newly created VLAN
- Enable tagging on selected ports if the port is in another VLAN
- Disable tagging if a selected port does not exist in another VLAN
- Exclude ports that are not selected from the VLAN
- Enable routing on the VLAN using the IP address and subnet mask entered as logical routing interface

DHCP Relay Agents relay DHCP requests from any routed interface, including VLANs, when DHCP server doesn't reside on the same IP network or subnet

- The agent relays requests from a subnet without a DHCP server to a server or next-hop agent on another subnet
- Unlike a router which switches IP packets transparently, a DHCP relay agent processes DHCP messages and generates new DHCP messages
- Supports DHCP Relay Option 82 circuit-id and remote-id for VLANs
- Multiple Helper IPs feature allows to configure a DHCP relay agent with multiple DHCP server addresses per routing interface and to use different server addresses for client packets arriving on different interfaces on the relay agent server addresses for client packets arriving on different interfaces on the relay agent

Virtual Router Redundancy Protocol (VRRP) provides backup for any statically allocated next-hop router address going down, based on RFC 3768 (IPv4)

- VRRP is based on the concept of having more than one router recognize the same router IP address
- VRRP increases the availability of the default path without requiring configuration of dynamic routing, or router discovery protocols on end stations
- Multiple virtual routers can be defined on any single router interface
- One of the routers is elected the master router and handles all traffic sent to the specified virtual router IP address
- When the master router fails, one of the backup routers is elected in its place and starts handling traffic sent to the address

Features Highlights

As an enhancement to RFC 3768, VRRP Interface can be configured as pingable to help troubleshoot network connectivity issues

- In that case, VRRP master responds to both fragmented and unfragmented ICMP echo requests packets destined to VRRP address(es)
- VRRP master responds with VRRP address as the source IPv4 address and VRMAC as the source MAC address
- A virtual router in backup state discards these ICMP echo requests

VRRP Route/Interface Tracking feature extends the capability of the Virtual Router Redundancy Protocol (VRRP)

- Allows tracking of specific route/interface IP states, within the router, that can alter the priority level of a virtual router for a VRRP group
- It ensures the best VRRP router is master for the group

Router Discovery Protocol is an extension to ICMP and enables hosts to dynamically discover the IP address of routers on local IP subnets

- Based on RFC 1256 for IPv4
- Routers periodically send router discovery messages to announce their presence to locally-attached hosts
- The router discovery message advertises one or more IP addresses on the router that hosts can use as their default gateway
- Hosts can send a router solicitation message asking any router that receives the message to immediately send a router advertisement
- Router discovery eliminates the need to manually configure a default gateway on each host
- It enables hosts to switch to a different default gateway if one goes down

Loopback interfaces are available as dynamic, stable IP addresses for other devices on the network, and for routing protocols

Tunnel interfaces are available for IPv4 and IPv6

- Each router interface (port, or VLAN interface) can have multiple associated tunnel interfaces
- Support for Configured 6to4 (RFC 4213) and Automatic 6to4 tunneling (RFC 3056) for IPv6 traffic encapsulation into IPv4 packets
- 6to4 tunnels are automatically formed for IPv4 tunnels carrying IPv6 traffic
- M4350 can act as a 6to4 border router that connects a 6to4 site to a 6to4 domain

Support of Routing Information Protocol (RIPv2) as a distance vector protocolspecified in RFC 2453 for IPv4

- Each route is characterized by the number of gateways, or hops, a packet must traverse to reach its intended destination
- Categorized as an interior gateway protocol, RIP operates within the scope of an autonomous system

Route Redistribution feature enables the exchange of routing information among different routing protocols all operating within a router

- Configurable when different routing protocols use different ways of expressing the distance to a destination or different metrics and formats
- For instance, when OSPF redistributes a route from RIP, and needs to know how to set each of the route's path attributes

Open Shortest Path First (OSPF) link-state protocol for IPv4 and IPv6

- For IPv4 networks, OSPF version 2 is supported in accordance with RFC 2328, including compatibility mode for the RFC 1583 older specification
- For IPv6 networks, OSPF version 3 is fully supported
- OSPF can operate within a hierarchy, the largest entity within the hierarchy is the autonomous system (AS)
- An AS is a collection of networks under a common administration sharing a common routing strategy (routing domain)
- An AS can be divided into a number of areas or groups of contiguous networks and attached hosts
- Two different types of OSPF routing occur as a result of area partitioning: Intra-area and Inter-area
- Intra-area routing occurs if a source and destination are in the same area
- Inter-area routing occurs when a source and destination are in different areas
- An OSPF backbone distributes information between areas

Features Highlights

Advanced OSPF implementation for large routing domains

- OSPF NSSA feature supports RFC 3101, The OSPF Not-So-Stubby Area (NSSA) Option
- Forwarding of OSPF Opaque LSAs is enabled by default
- Passive interface feature can disable sending OSPF routing updates on an interface
- Static Area Range Costs feature allows to configure a fixed OSPF cost that is always advertised when an area range is active
- OSPF Equal Cost Multipath (ECMP) feature allows to forward traffic through multiple paths, taking advantage of more bandwidth
- ECMP routes can be learned dynamically, or configured statically with multiple static routes to same destination but with different next hops
- OSPF Max Metric feature allows to override the metric in summary type 3 and type 4 LSAs while in stub router mode
- Automatic Exiting of Stub Router Mode feature allows to exit stub router mode, reoriginating the router LSA with proper metric values on transit links
- Static Area Range Costs feature allows to configure a fixed OSPF cost that is always advertised when an area range is active

OSPF LSA Pacing feature improves the efficiency of LSA flooding, reducing or eliminating the packet drops caused by bursts in OSPF control packets

- LSA transmit pacing limits the rate of LS Update packets that OSPF can send
- With LSA refresh groups, OSPF efficiently bundles LSAs into LS Update packets when periodically refreshing self-originated LSAs

OSPF Flood Blocking feature allows to disable LSA flooding on an interface with area or AS (domain-wide) scope

- In that case, OSPF does not advertise any LSAs with area or AS scope in its database description packets sent to neighbors

OSPF Transit-Only Network Hiding is supported based on RFC 6860 with transit-only network defined as a network connecting only routers

- Transit-only networks are usually configured with routable IP addresses which are advertised in LSAs but are not needed for data traffic
- If router-to-router subnets are advertised, remote attacks can be launched against routers by sending packets to these transit-only networks
- Hiding transit-only networks speeds up network convergence and reduces vulnerability to remote attacks
- 'Hiding' implies that the prefixes are not installed in the routing tables on OSPFv2 and OSPFv3 routers

IP Multinetting allows to configure more than one IP address on a network interface (other vendors may call it IP Aliasing or Secondary Addressing)

ICMP Throttling feature adds configuration options for the transmission of various types of ICMP messages

- ICMP Redirects can be used by a malicious sender to perform man-in-the-middle attacks, or divert packets to a malicious monitor, or to cause Denial of Service (DoS) by blackholing the packets
- ICMP Echo Requests and other messages can be used to probe for vulnerable hosts or routers
- Rate limiting ICMP error messages protects the local router and the network from sending a large number of messages that take CPU and bandwidth

The Policy Based Routing feature (PBR) overrides routing decision taken by the router and makes the packet to follow different actions based on a policy

- It provides freedom over packet routing/forwarding instead of leaving the control to standard routing protocols based on L3
- For instance, some organizations would like to dictate paths instead of following the paths shown by routing protocols
- Network Managers/Administrators can set up policies such as:
 - My network will not carry traffic from the Engineering department
 - Traffic originating within my network with the following characteristics will take path A, while other traffic will take path B
 - When load sharing needs to be done for the incoming traffic across multiple paths based on packet entities in the incoming traffic

Enterprise security

Traffic control MAC Filter and Port Security help restrict the traffic allowed into and out of specified ports or interfaces in the system in order to increase overall security and block MAC address flooding issues

DHCP Snooping monitors DHCP traffic between DHCP clients and DHCP servers to filter harmful DHCP message and builds a bindings database of (MAC address, IP address, VLAN ID, port) tuples that are considered authorized in order to prevent DHCP server spoofing attacks

IP source guard and Dynamic ARP Inspection use the DHCP snooping bindings database per port and per VLAN to drop incoming packets that do not match any binding and to enforce source IP/MAC addresses for malicious users traffic elimination

Features Highlights

Time-based Layer 2 / Layer 3-v4 / Layer 3-v6 / Layer 4 Access Control Lists (ACLs) can be binded to ports, Layer 2 interfaces, VLANs and LAGs (Link Aggregation Groups or Port channel) for fast unauthorized data prevention and right granularity

For in-band switch management, management ACLs on CPU interface (Control Plane ACLs) are used to define the IP/MAC or protocol through which management access is allowed for increased HTTP/HTTPS or Telnet/SSH management security

Out-of-band management is available via dedicated service port (1G RJ45 OOB) when in-band management can be prohibited via management ACLs

Bridge protocol data unit (BPDU) Guard allows the network administrator to enforce the Spanning Tree (STP) domain borders and keep the active topology consistent and predictable - unauthorized devices or switches behind the edge ports that have BPDU enabled will not be able to influence the overall STP by creating loops

Spanning Tree Root Guard (STRG) enforces the Layer 2 network topology by preventing rogue root bridges potential issues when for instance, unauthorized or unexpected new equipment in the network may accidentally become a root bridge for a given VLAN

Dynamic 802.1x VLAN assignment mode, including Dynamic VLAN creation mode and Guest VLAN / Unauthenticated VLAN are supported for rigorous user and equipment RADIUS policy server enforcement

- Up to 48 clients (802.1x) per port are supported, including the authentication of the users domain, in order to facilitate convergent deployments. For instance when IP phones connect PCs on their bridge, IP phones and PCs can authenticate on the same switch port but under different VLAN assignment policies (Voice VLAN versus other Production VLANs)

802.1x MAC Address Authentication Bypass (MAB) is a supplemental authentication mechanism that lets non-802.1x devices bypass the traditional 802.1x process altogether, letting them authenticate to the network using their client MAC address as an identifier

- A list of authorized MAC addresses of client NICs is maintained on the RADIUS server for MAB purpose
- MAB can be configured on a per-port basis on the switch
- MAB initiates after unsuccessful dot1x authentication process (configurable time out), when clients don't respond to any of EAPOL packets
- When 802.1X unaware clients try to connect, the switch sends the MAC address of each client to the authentication server
- The RADIUS server checks the MAC address of the client NIC against the list of authorized addresses
- The RADIUS server returns the access policy and VLAN assignment to the switch for each client

With Successive Tiering, the Authentication Manager allows for authentication methods per port for a Tiered Authentication based on configured time-outs

- By default, configuration authentication methods are tried in this order: Dot1x, then MAB, then Captive Portal (web authentication)
- With BYOD, such Tiered Authentication is powerful and simple to implement with strict policies
- For instance, when a client is connecting, M4300 tries to authenticate the user/client using the three methods above, the one after the other
- The admin can restrict the configuration such that no other method is allowed to follow the captive portal method, for instance

Double VLANs (DVLAN) pass traffic from one customer domain to another through the "metro core" in a multi-tenancy environment: customer VLAN IDs are preserved and a service provider VLAN ID is added to the traffic so the traffic can pass the metro core in a simple, secure manner

Private VLANs (with Primary VLAN, Isolated VLAN, Community VLAN, Promiscuous port, Host port, Trunks) provide Layer 2 isolation between ports that share the same broadcast domain, allowing a VLAN broadcast domain to be partitioned into smaller point-to-multipoint subdomains across switches in the same Layer 2 network

- Private VLANs are useful in DMZ when servers are not supposed to communicate with each other but need to communicate with a router
- They remove the need for more complex port-based VLANs with respective IP interface/subnets and associated L3 routing
- Another Private VLANs typical application are carrier-class deployments when users shouldn't see, snoop or attack other users' traffic

SSL version 3 and TLS version 2 ensure Web GUI sessions are secured

Secure Shell (SSH version 2) and SNMPv3 (with or without MD5 or SHA authentication) ensure SNMP and Telnet sessions are secured

2048-bit RSA key pairs, SHA2-256 and SHA2-512 cryptographic hash functions for SSLv3 and SSHv2 are supported on all M4300 models

TACACS+ and RADIUS enhanced administrator management provides strict "Login" and "Enable" authentication enforcement for the switch configuration, based on latest industry standards: exec authorization using TACACS+ or RADIUS; command authorization using TACACS+ and RADIUS Server; user exec accounting for HTTP and HTTPS using TACACS+ or RADIUS; and authentication based on user domain in addition to user ID and password

Features Highlights

Superior quality of service

Advanced classifier-based hardware implementation for Layer 2 (MAC), Layer 3 (IP) and Layer 4 (UDP/TCP transport ports) prioritization

8 queues for priorities and various QoS policies based on 802.1p (CoS) and DiffServ can be applied to interfaces and VLANs

Advanced rate limiting down to 1 Kbps granularity and minimum-guaranteed bandwidth can be associated with ACLs for best granularity

Single Rate Policing feature enables support for Single Rate Policer as defined by RFC 2697

- Committed Information Rate (average allowable rate for the class)
- Committed Burst Size (maximum amount of contiguous packets for the class)
- Excessive Burst Size (additional burst size for the class with credits refill at a slower rate than committed burst size)
- DiffServ feature applied to class maps

Automatic Voice over IP prioritization with protocol-based (SIP, H323 and SCCP) or OUI-based Auto-VoIP up to 144 simultaneous voice calls

Flow Control

802.3x Flow Control implementation per IEEE 802.3 Annex 31B specifications with Symmetric flow control, Asymmetric flow control or No flow control

- Asymmetric flow control allows the switch to respond to received PAUSE frames, but the ports cannot generate PAUSE frames
- Symmetric flow control allows the switch to both respond to, and generate MAC control PAUSE frames

Allows traffic from one device to be throttled for a specified period of time: a device that wishes to inhibit transmission of data frames from another device on the LAN transmits a PAUSE frame

- A device that wishes to inhibit transmission of data frames from another device on the LAN transmits a PAUSE frame
- Limitation: Enabling, changing, or disabling flow control on a port, a service interruption is observed on that port during 4 to 6 seconds before the traffic resumes

UDLD Support

UDLD implementation detects unidirectional links physical ports (UDLD must be enabled on both sides of the link in order to detect an unidirectional link)

- UDLD protocol operates by exchanging packets containing information about neighboring devices
- The purpose is to detect and avoid unidirectional link forwarding anomalies in a Layer 2 communication channel

Both "normal-mode" and "aggressive-mode" are supported for perfect compatibility with other vendors implementations, including port "D-Disable" triggering cases in both modes



AV Target Application

Core

At the core, two powerful M4350 models can be stacked*. For maximum performance, and best reliability, two switches should be the limit

- Management unit hitless failover and nonstop forwarding ensure no single point of failure
- The interconnect should provide headroom: for instance, all the multicast present in the network will be replicated between the two core switches

Building 1 to 5

- Each M4350 model connects to the core using distributed link aggregation (LACP, fully automatic with Auto-LAG and Auto-Trunk)
- In case of one core switch failure, there is no service interruption

Centrally managed by the NETGEAR Engage™ Controller

- Simplify your AV multicast deployments with NETGEAR IGMP Plus™ which prevents any multicast flooding for your Professional AV, Medical AV, Residential AV, Broadcast AV, Lighting installations, and more.
- Centrally available in Engage, the revolutionary NETGEAR AV user interface contains pre-configured profiles for all major audio, video, and lighting protocols including: AVB, Dante, Q-SYS, AES67, NVX, AMX, Q-SYS, NDI 4, NDI 5, ZeeVee, Aurora Multimedia, Kramer, Atlona, LibAV, Visionary, SDVoE and others. SMPTE ST 2110 is supported on select models

* Stacking, AVB, and PTP TC are mutually exclusive features. A stack cannot run AVB, nor PTP TC (or BC/GM).

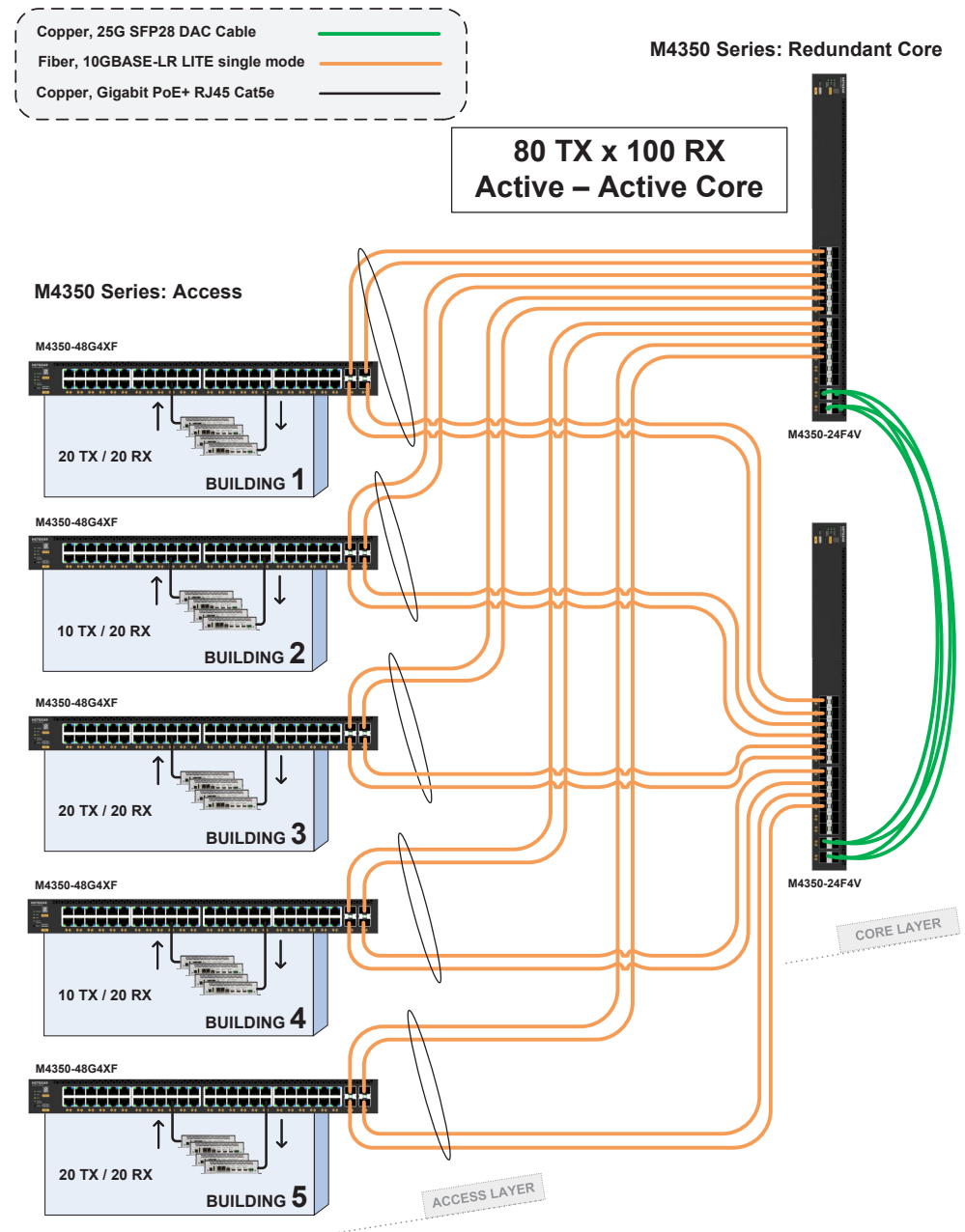

IT Target Application

Core

At the core, two powerful M4350 models can be stacked. For maximum performance, and best reliability, two switches should be the limit

- Management unit hitless failover and nonstop forwarding ensure no single point of failure
- The interconnect should provide headroom: for instance, all the multicast in the present network will be replicated between the two core switches

Building 1

- For midsize server installations, two half-width M4350 10GbE models can be paired in a single rack space for redundant top-of-rack
- Management unit hitless failover and nonstop forwarding ensure no single point of failure for servers and storage

Building 2

- Common for intermediate distribution frames (IDF) in K-12 and other large campuses, stacking topologies greatly simplify deployments at the edge
- While reducing the number of logical units to manage, stacking also brings network resiliency with distributed uplinks in aggregation to the core

Building 3

- For typical collapsed core installations, with a variety of 1G, 2.5G, 10G, and 25G access ports in branch offices, server rooms or campus high performance labs
- Double star architectures deliver highest performance with every leaf switch connecting to every spine switch

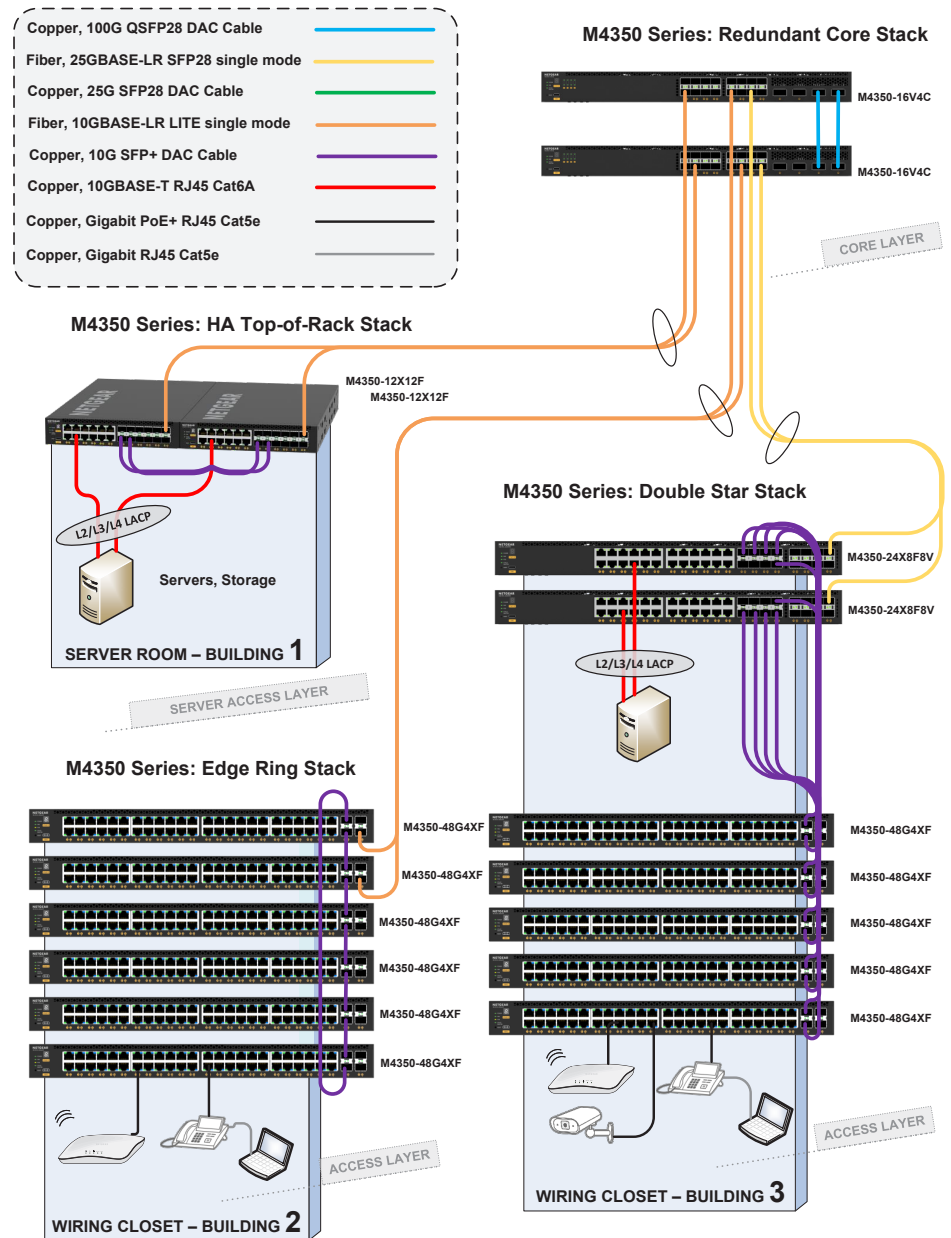

Components

M4350-24G4XF

Fully Managed Switch

Ordering information

- Americas, Europe: GSM4328-100NES (NA, UK, EU)
- Asia Pacific: GSM4328-100AJS (JP, AU)
- China: GSM4328-100PRS
- Warranty: Lifetime ProSAFE Hardware Warranty



PSU Ordering information

- APS350W-100NES (NA, UK, EU)/ -100AJS (JP, AU)/ -10000S (no power cord)
- APS600W-200NES (NA, UK, EU)/ -200AJS (JP, AU)/ -20000S (no power cord)
- APS920W-100NES (NA, UK, EU)/ -100AJS (JP, AU)/ -10000S (no power cord)
- APS2000W-100NES (NA, UK, EU)/ -100AJS (JP, AU)/ -10000S (no power cord)

- 24 Gigabit PoE+ ports with 4 10GBASE-X SFP+ uplinks.
- 880W internal power supply providing 648W of PoE budget.
- 1 slot for modular power supply (1+1 redundancy and/or EPS share).
- Any APS350W, APS600Wv2, APS920W, or APS2000W can be used.
- The PoE budget can reach 720W, when the redundant PoE budget remains 648W.
- Virtual Chassis stacking provides non-stop forwarding (NSF) and hitless failover.
- Layer 3 feature set includes static, policy-based, and dynamic routing.
- NETGEAR IGMP Plus™, AV User Interface, and Engage Controller speed up AV installations.
- NETGEAR ProSAFE® Limited Lifetime Hardware Warranty.
- Lifetime Next Business Day Hardware Replacement.
- Dimensions: 440*400*43.2 mm
- Weight: 6.41Kg (14.13 lb)



Components

M4350-48G4XF

Fully Managed Switch

Ordering information

- Americas, Europe: GSM4352-100NES (NA, UK, EU)
- Asia Pacific: GSM4352-100AJS (JP, AU)
- China: GSM4352-100PRS
- Warranty: Lifetime ProSAFE Hardware Warranty



PSU Ordering information

- APS350W-100NES (NA, UK, EU)/ -100AJS (JP, AU)/ -10000S (no power cord)
- APS600W-200NES (NA, UK, EU)/ -200AJS (JP, AU)/ -20000S (no power cord)
- APS920W-100NES (NA, UK, EU)/ -100AJS (JP, AU)/ -10000S (no power cord)
- APS2000W-100NES (NA, UK, EU)/ -100AJS (JP, AU)/ -10000S (no power cord)

- 48 Gigabit PoE+ ports with 4 10GBASE-X SFP+ uplinks.
- 550W internal power supply providing 236W of PoE budget.
- 2 slots for modular power supplies (1+1 redundancy and/or EPS share).
- Any APS350W, APS600Wv2, APS920W, or APS2000W can be used.
- The PoE budget can reach 1,440W, the redundant PoE budget can also reach 1,440W.
- Virtual Chassis stacking provides non-stop forwarding (NSF) and hitless failover.
- Layer 3 feature set includes static, policy-based, and dynamic routing.
- NETGEAR IGMP Plus™, AV User Interface, and Engage Controller speed up AV installations.
- NETGEAR ProSAFE® Limited Lifetime Hardware Warranty.
- Lifetime Next Business Day Hardware Replacement.
- Dimensions: 440x400x43.2 mm
- Weight: 7.19Kg (15.85 lb)



Components

M4350-44M4X4V

Fully Managed Switch

Ordering information

- Americas, Europe: MSM4352-100NES (NA, UK, EU)
- Americas, TAA Compliant: MSM4352-TAANES (NA, UK, EU)
- Asia Pacific: MSM4352-100AJS (JP, AU)
- China: MSM4352-100PRS
- Warranty: Lifetime ProSAFE Hardware Warranty



PSU Ordering information

- APS350W-100NES (NA, UK, EU)/ -100AJS (JP, AU)/ -10000S (no power cord)
- APS600W-200NES (NA, UK, EU)/ -200AJS (JP, AU)/ -20000S (no power cord)
- APS920W-100NES (NA, UK, EU)/ -100AJS (JP, AU)/ -10000S (no power cord)
- APS2000W-100NES (NA, UK, EU)/ -100AJS (JP, AU)/ -10000S (no power cord)

- 44 2.5G and 4 10G/Multi-gig PoE++ ports with 4 25GBASE-X SFP28 uplinks.
- Fast Ethernet (100Mbps) only supported on 2.5G ports 1-44.
- 10 Gigabit only, or 25 Gigabit only supported on SFP28 ports 49-52.
- 550W internal power supply providing 194W of PoE budget
- 2 slots for modular power supplies (1+1 redundancy and/or EPS share).
- Any APS350W, APS600Wv2, APS920W, or APS2000W can be used.
- The PoE budget can reach 3,314W, the redundant PoE budget can reach 1,794W.
- Virtual Chassis stacking provides non-stop forwarding (NSF) and hitless failover.
- Layer 3 feature set includes static, policy-based, and dynamic routing.
- NETGEAR IGMP Plus™, AV User Interface, and Engage Controller speed up AV installations.
- NETGEAR ProSAFE® Limited Lifetime Hardware Warranty.
- Lifetime Next Business Day Hardware Replacement.
- Dimensions: 440x400x43.2 mm
- Weight: 7.34Kg (16.18 lb)



Components

M4350-8X8F

Fully Managed Switch

Ordering information

- Americas, Europe: XSM4316-100NES (NA, UK, EU)
- Asia Pacific: XSM4316-100AJS (JP, AU)
- China: XSM4316-100PRS
- Warranty: Lifetime ProSAFE Hardware Warranty

- 8 10G/Multi-Gig ports, and 8 10GBASE-X SFP+ ports.
- Gigabit (1000Mbps) only supported on Copper ports 1-8 and SFP+ ports 9-12.
- 240W internal power supply.
- Half-width form factor enables one or two switches in a single rack space for redundant top-of-rack.
- Virtual Chassis stacking provides non-stop forwarding (NSF) and hitless failover.
- Layer 3 feature set includes static, policy-based, and dynamic routing.
- NETGEAR IGMP Plus™, AV User Interface, and Engage Controller speed up AV installations.
- NETGEAR ProSAFE® Limited Lifetime Hardware Warranty.
- Lifetime Next Business Day Hardware Replacement.
- Dimensions: 220x400x43.2 mm
- Weight: 4.05Kg (8.93 lb)

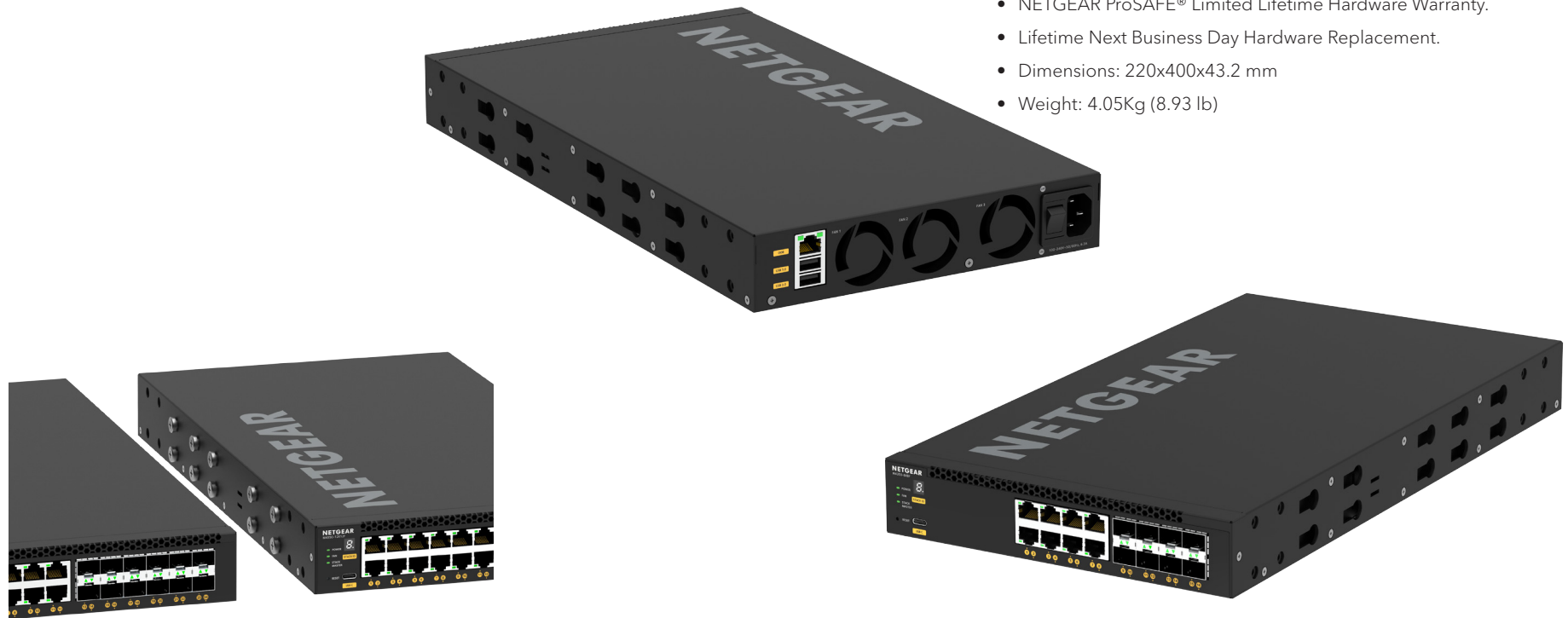

Components

M4350-12X12F

Fully Managed Switch

Ordering information

- Americas, Europe: XSM4324-100NES (NA, UK, EU)
- Asia Pacific: XSM4324-100AJS (JP, AU)
- China: XSM4324-100PRS
- Warranty: Lifetime ProSAFE Hardware Warranty

- 12 10G/Multi-Gig ports, and 12 10GBASE-X SFP+ ports.
- Gigabit (1000Mbps) only supported on Copper ports 1-12 and SFP+ ports 13-20.
- 240W internal power supply.
- Half-width form factor enables one or two switches in a single rack space for redundant top-of-rack.
- Virtual Chassis stacking provides non-stop forwarding (NSF) and hitless failover.
- Layer 3 feature set includes static, policy-based, and dynamic routing.
- NETGEAR IGMP Plus™, AV User Interface, and Engage Controller speed up AV installations.
- NETGEAR ProSAFE® Limited Lifetime Hardware Warranty.
- Lifetime Next Business Day Hardware Replacement.
- Dimensions: 220x400x43.2 mm
- Weight: 4.3Kg (9.48 lb)



Components

M4350-24X4V

Fully Managed Switch

Ordering information

- Americas, Europe: XSM4328CV-100NES (NA, UK, EU)
- Americas, TAA Compliant: XSM4328CV-TAANES (NA, UK, EU)
- Asia Pacific: XSM4328CV-100AJS (JP, AU)
- China: XSM4328CV-100PRS
- Warranty: Lifetime ProSAFE Hardware Warranty



PSU Ordering information

- APS350W-100NES (NA, UK, EU)/ -100AJS (JP, AU)/ -10000S (no power cord)
- APS600W-200NES (NA, UK, EU)/ -200AJS (JP, AU)/ -20000S (no power cord)
- APS920W-100NES (NA, UK, EU)/ -100AJS (JP, AU)/ -10000S (no power cord)
- APS2000W-100NES (NA, UK, EU)/ -100AJS (JP, AU)/ -10000S (no power cord)

- 24 10G/Multi-Gig PoE+ ports with 4 25GBASE-X SFP28 uplinks.
- Fast Ethernet (100Mbps) only supported on Copper ports 1-16.
- 10 Gigabit only, or 25 Gigabit only supported on SFP28 ports 25-28.
- 880W internal power supply providing 576W of PoE budget.
- 1 slot for modular power supply (1+1 redundancy and/or EPS share).
- Any APS350W, APS600Wv2, APS920W, or APS2000W can be used.
- The PoE budget can reach 720W, when the redundant PoE budget remains 576W.
- Virtual Chassis stacking provides non-stop forwarding (NSF) and hitless failover.
- Layer 3 feature set includes static, policy-based, and dynamic routing.
- NETGEAR IGMP Plus™, AV User Interface, and Engage Controller speed up AV installations.
- NETGEAR ProSAFE® Limited Lifetime Hardware Warranty.
- Lifetime Next Business Day Hardware Replacement.
- Dimensions: 440x400x43.2 mm
- Weight: 6.58Kg (14.51 lb)



Components

M4350-24F4V

Fully Managed Switch

Ordering information

- Americas, Europe: XSM4328FV-100NES (NA, UK, EU)
- Asia Pacific: XSM4328FV-100AJS (JP, AU)
- China: XSM4328FV-100PRS
- Warranty: Lifetime ProSAFE Hardware Warranty



PSU Ordering information

- APS350W-100NES (NA, UK, EU)/ -100AJS (JP, AU)/ -10000S (no power cord)
- APS600W-200NES (NA, UK, EU)/ -200AJS (JP, AU)/ -20000S (no power cord)
- APS920W-100NES (NA, UK, EU)/ -100AJS (JP, AU)/ -10000S (no power cord)
- APS2000W-100NES (NA, UK, EU)/ -100AJS (JP, AU)/ -10000S (no power cord)

- 24 10GBASE-X SFP+ ports with 4 25GBASE-X SFP28 uplinks.
- Gigabit (1000Mbps) only supported on SFP+ ports 1-16.
- 10 Gigabit only, or 25 Gigabit only supported on SFP28 ports 25-28.
- 240W internal power supply.
- 1 slot for modular power supply (1+1 redundancy).
- Any APS350W, APS600Wv2, APS920W, or APS2000W can be used.
- Virtual Chassis stacking provides non-stop forwarding (NSF) and hitless failover.
- Layer 3 feature set includes static, policy-based, and dynamic routing.
- NETGEAR IGMP Plus™, AV User Interface, and Engage Controller speed up AV installations.
- NETGEAR ProSAFE® Limited Lifetime Hardware Warranty.
- Lifetime Next Business Day Hardware Replacement.
- Dimensions: 440x400x43.2 mm
- Weight: 6.25Kg (13.78 lb)



Components

M4350-36X4V

Fully Managed Switch

Ordering information

- Americas, Europe: XSM4340CV-100NES (NA, UK, EU)
- Asia Pacific: XSM4340CV-100AJS (JP, AU)
- China: XSM4340CV-100PRS
- Warranty: Lifetime ProSAFE Hardware Warranty



PSU Ordering information

- APS600W-300NES (NA, UK, EU)/ -300AJS (JP, AU)/ -30000S (no power cord)
- APS1200W-200NES (NA, UK, EU)/ -200AJS (JP, AU)/ -20000S (no power cord)
- APS2000W-200NES (NA, UK, EU)/ -200AJS (JP, AU)/ -20000S (no power cord)

- 36 10G/Multi-Gig PoE++ ports with 4 25GBASE-X SFP28 uplinks.
- Fast Ethernet (100Mbps) only supported on ports 1-28.
- 10 Gigabit only, or 25 Gigabit only supported on SFP28 ports 25-28.
- 750W internal power supply providing 280W of PoE budget.
- 1 slot for modular power supply (1+1 redundancy and/or EPS share).
- Any APS600Wv3, APS1200Wv2, or APS2000Wv2 can be used.
- The PoE budget can reach 1,760W, when the redundant PoE budget remains 280W.
- Virtual Chassis stacking provides non-stop forwarding (NSF) and hitless failover.
- Layer 3 feature set includes static, policy-based, and dynamic routing.
- NETGEAR IGMP Plus™, AV User Interface, and Engage Controller speed up AV installations.
- NETGEAR ProSAFE® Limited Lifetime Hardware Warranty.
- Lifetime Next Business Day Hardware Replacement.
- Dimensions: 440x400x43.2 mm
- Weight: 7.33Kg (16.16 lb)



Components

M4350-24X8F8V

Fully Managed Switch

Ordering information

- Americas, Europe: XSM4340V-100NES (NA, UK, EU)
- Americas, TAA Compliant: XSM4340V-TAANES (NA, UK, EU)
- Asia Pacific: XSM4340V-100AJS (JP, AU)
- China: XSM4340V-100PRS
- Warranty: Lifetime ProSAFE Hardware Warranty



PSU Ordering information

- APS600W-300NES (NA, UK, EU)/ -300AJS (JP, AU)/ -30000S (no power cord)
- APS1200W-200NES (NA, UK, EU)/ -200AJS (JP, AU)/ -20000S (no power cord)
- APS2000W-200NES (NA, UK, EU)/ -200AJS (JP, AU)/ -20000S (no power cord)

- 24 10G/Multi-Gig PoE++ ports, 8 10GBASE-X SFP+ and 8 25GBASE-X SFP28 ports.
- Fast Ethernet (100Mbps) is supported on Copper ports 1-24.
- Gigabit (1000Mbps) only supported on SFP+ ports 25-28
- 10 Gigabit only, or 25 Gigabit only on SFP28 ports 33-40, per 4-port block.
- 750W internal power supply providing 290W of PoE budget.
- 1 slot for modular power supply (1+1 redundancy and/or EPS share).
- Any APS600Wv3, APS1200Wv2, or APS2000Wv2 can be used.
- The PoE budget can reach 1,770W, when the redundant PoE budget remains 290W.
- Virtual Chassis stacking provides non-stop forwarding (NSF) and hitless failover.
- Layer 3 feature set includes static, policy-based, and dynamic routing.
- NETGEAR IGMP Plus™, AV User Interface, and Engage Controller speed up AV installations.
- NETGEAR ProSAFE® Limited Lifetime Hardware Warranty.
- Lifetime Next Business Day Hardware Replacement.
- Dimensions: 440x400x43.2 mm
- Weight: 7.24Kg (15.96 lb)



Components

M4350-32F8V

Fully Managed Switch

Ordering information

- Americas, Europe: XSM4340FV-100NES (NA, UK, EU)
- Americas, TAA Compliant: XSM4340FV-TAANES (NA, UK, EU)
- Asia Pacific: XSM4340FV-100AJS (JP, AU)
- China: XSM4340FV-100PRS
- Warranty: Lifetime ProSAFE Hardware Warranty



PSU Ordering information

- APS600W-300NES (NA, UK, EU)/ -300AJS (JP, AU)/ -30000S (no power cord)
- APS1200W-200NES (NA, UK, EU)/ -200AJS (JP, AU)/ -20000S (no power cord)
- APS2000W-200NES (NA, UK, EU)/ -200AJS (JP, AU)/ -20000S (no power cord)

- 32 10GBASE-X SFP+ ports with 8 25GBASE-X SFP28 uplinks.
- Gigabit (1000Mbps) only supported on SFP+ ports 1-28.
- 10 Gigabit only, or 25 Gigabit only on SFP28 ports 33-40, per 4-port block
- 420W internal power supply
- 1 slot for modular power supply (1+1 redundancy).
- Any APS600Wv3, APS1200Wv2, or APS2000Wv2 can be used.
- Virtual Chassis stacking provides non-stop forwarding (NSF) and hitless failover.
- Layer 3 feature set includes static, policy-based, and dynamic routing.
- NETGEAR IGMP Plus™, AV User Interface, and Engage Controller speed up AV installations.
- NETGEAR ProSAFE® Limited Lifetime Hardware Warranty.
- Lifetime Next Business Day Hardware Replacement.
- Dimensions: 440x400x43.2 mm
- Weight: 6.95Kg (15.32 lb)



Components

M4350-16V4C

Fully Managed Switch

Ordering information

- Americas, Europe: VSM4320C-100NES (NA, UK, EU)
- Americas, TAA Compliant: VSM4320C-TAANES (NA, UK, EU)
- Asia Pacific: VSM4320C-100AJS (JP, AU)
- China: VSM4320C-100PRS
- Warranty: Lifetime ProSAFE Hardware Warranty



PSU Ordering information

- APS600W-300NES (NA, UK, EU)/ -300AJS (JP, AU)/ -30000S (no power cord)
- APS1200W-200NES (NA, UK, EU)/ -200AJS (JP, AU)/ -20000S (no power cord)
- APS2000W-200NES (NA, UK, EU)/ -200AJS (JP, AU)/ -20000S (no power cord)

- 16 25GBASE-X SFP28 ports with 4 100GBASE-X QSFP28 uplinks.
- 10 Gigabit only, or 25 Gigabit only on SFP28 ports 1-16, per 4-port block.
- 420W internal power supply
- 1 slot for modular power supply (1+1 redundancy).
- Any APS600Wv3, APS1200Wv2, or APS2000Wv2 can be used.
- Virtual Chassis stacking provides non-stop forwarding (NSF) and hitless failover.
- Layer 3 feature set includes static, policy-based, and dynamic routing.
- NETGEAR IGMP Plus™, AV User Interface, and Engage Controller speed up AV installations.
- NETGEAR ProSAFE® Limited Lifetime Hardware Warranty.
- Lifetime Next Business Day Hardware Replacement.
- Dimensions: 440x400x43.2 mm
- Weight: 7.15Kg (15.77 lb)



Components

M4350-40X4C

Fully Managed Switch

Ordering information

- Americas, Europe: XSM4344C-100NES (NA, UK, EU)
- Americas, TAA Compliant: XSM4344C-TAANES (NA, UK, EU)
- Asia Pacific: XSM4344C-100AJS (JP, AU)
- China: XSM4344C-100PRS
- Warranty: Lifetime ProSAFE Hardware Warranty



PSU Ordering information

- APS600W-300NES (NA, UK, EU)/ -300AJS (JP, AU)/ -30000S (no power cord)
- APS1200W-200NES (NA, UK, EU)/ -200AJS (JP, AU)/ -20000S (no power cord)
- APS2000W-200NES (NA, UK, EU)/ -200AJS (JP, AU)/ -20000S (no power cord)

- 40 10G/Multi-Gig PoE++ ports with 4 100GBASE-X QSFP28 uplinks.
- Fast Ethernet (100Mbps) is not supported, on any port.
- 750W internal power supply providing 196W of PoE budget.
- 1 slot for modular power supply (1+1 redundancy and/or EPS share).
- Any APS600Wv3, APS1200Wv2, or APS2000Wv2 can be used.
- The PoE budget can reach 1,676W, when the redundant PoE budget remains 196W.
- Virtual Chassis stacking provides non-stop forwarding (NSF) and hitless failover.
- Layer 3 feature set includes static, policy-based, and dynamic routing.
- NETGEAR IGMP Plus™, AV User Interface, and Engage Controller speed up AV installations.
- NETGEAR ProSAFE® Limited Lifetime Hardware Warranty.
- Lifetime Next Business Day Hardware Replacement.
- Dimensions: 440x400x43.2 mm
- Weight: 7.76Kg (17.11 lb)

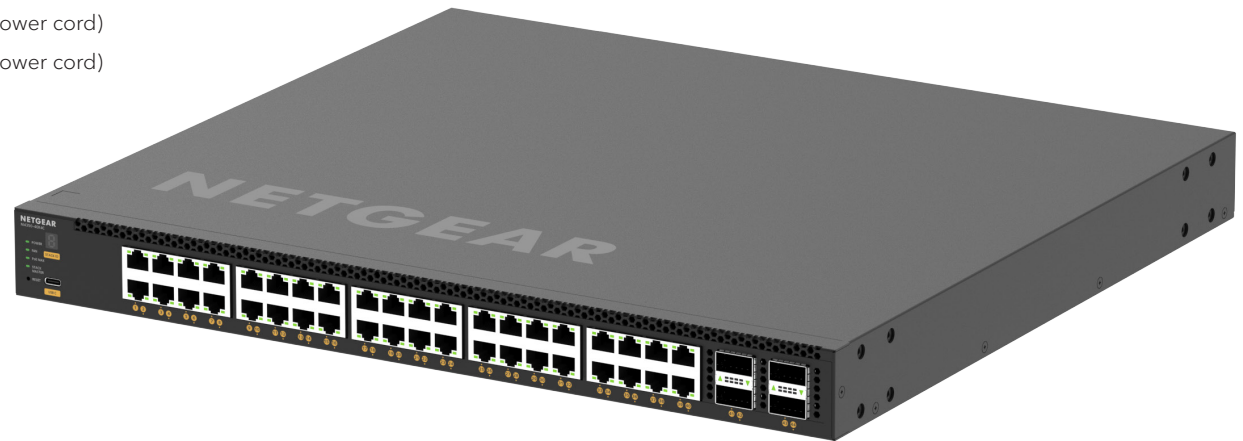

Components

APS350W

Power Supply Unit

Ordering information

- Americas, Europe: APS350W-100NES (NA, UK, EU)
- Asia Pacific: APS350W-100AJS (JP, AU)
- Asia Pacific: APS350W-10000S (no power cord)
- Warranty: 5 years



- PSU for M4350-24G4XF (GSM4328), M4350-48G4XF (GSM4352), M4350-44M4X4V (MSM4352), M4350-24X4V (XSM4328CV), and M4350-24F4V (XSM4328FV).
- C14 connector.
- 110V-240V AC power input.
- Up to 350W output power at 110/220V AC.
- 5-Year Warranty

APS600Wv2

Power Supply Unit

Ordering information

- Americas, Europe: APS600W-200NES (NA, UK, EU)
- Asia Pacific: APS600W-200AJS (JP, AU)
- Asia Pacific: APS600W-20000S (no power cord)
- Warranty: 5 years



- PSU for M4350-24G4XF (GSM4328), M4350-48G4XF (GSM4352), M4350-44M4X4V (MSM4352), M4350-24X4V (XSM4328CV), and M4350-24F4V (XSM4328FV).
- C14 connector.
- 110V-240V AC power input.
- Up to 600W output power at 110/220V AC.
- 5-Year Warranty

Components

APS600Wv3

Power Supply Unit

Ordering information

- Americas, Europe: APS600W-300NES (NA, UK, EU)
- Asia Pacific: APS600W-300AJS (JP, AU)
- Asia Pacific: APS600W-30000S (no power cord)
- Warranty: 5 years

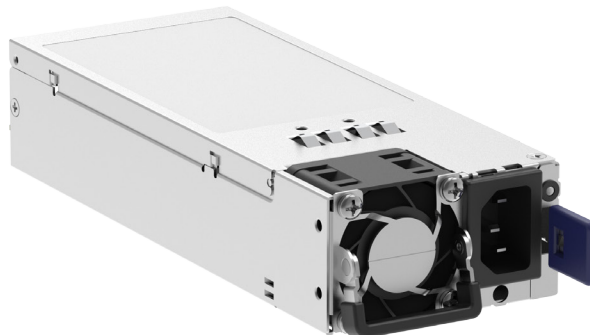

- PSU for M4350-36X4V (XSM4340CV), M4350-24X8F8V (XSM4340V), M4350-32F8V (XSM4340FV), M4350-16V4C (VSM4320C), and M4350-40X4C (XSM4344C).
- C14 connector.
- 110V-240V AC power input.
- Up to 600W output power at 110/220V AC.
- 5-Year Warranty

APS920W

Power Supply Unit

Ordering information

- Americas, Europe: APS920W-100NES (NA, UK, EU)
- Asia Pacific: APS920W-100AJS (JP, AU)
- Asia Pacific: APS920W-10000S (no power cord)
- Warranty: 5 years



- PSU for M4350-24G4XF (GSM4328), M4350-48G4XF (GSM4352), M4350-44M4X4V (MSM4352), M4350-24X4V (XSM4328CV), and M4350-24F4V (XSM4328FV).
- C14 connector.
- 110V-240V AC power input.
- Up to 920W output power at 110/220V AC.
- 5-Year Warranty

Components

APS1200Wv2

Power Supply Unit

Ordering information

- Americas, Europe: APS1200W-200NES (NA, UK, EU)
- Asia Pacific: APS1200W-200AJS (JP, AU)
- Asia Pacific: APS1200W-20000S (no power cord)
- Warranty: 5 years



- PSU for M4350-36X4V (XSM4340CV), M4350-24X8F8V (XSM4340V), M4350-32F8V (XSM4340FV), M4350-16V4C (VSM4320C), and M4350-40X4C (XSM4344C).
- C14 connector.
- 110V-240V AC power input.
- Up to 1,200W output power at 110/220V AC.
- 5-Year Warranty

APS2000W

Power Supply Unit

Ordering information

- Americas, Europe: APS2000W-100NES (NA, UK, EU)
- Asia Pacific: APS2000W-100AJS (JP, AU)
- Asia Pacific: APS2000W-10000S (no power cord)
- Warranty: 5 years



- PSU for M4350-24G4XF (GSM4328), M4350-48G4XF (GSM4352), M4350-44M4X4V (MSM4352), M4350-24X4V (XSM4328CV), and M4350-24F4V (XSM4328FV).
- C14 connector.
- 110V-240V AC power input.
- Up to 1,000W output power at 110V AC.
- Up to 2,000W output power at 220V AC.
- 5-Year Warranty

Components

APS2000Wv2 Power Supply Unit

Ordering information

- Americas, Europe: APS2000W-200NES (NA, UK, EU)
- Asia Pacific: APS2000W-200AJS (JP, AU)
- Asia Pacific: APS2000W-20000S (no power cord)
- Warranty: 5 years





- PSU for M4350-36X4V (XSM4340CV), M4350-24X8F8V (XSM4340V), M4350-32F8V (XSM4340FV), M4350-16V4C (VSM4320C), and M4350-40X4C (XSM4344C).
- C14 connector.
- 110V-240V AC power input.
- Up to 1,000W output power at 110V AC.
- Up to 2,000W output power at 220V AC.
- 5-Year Warranty



Accessories

GBIC SFP and SFP+ Optics for M4350 series

Ordering information <ul style="list-style-type: none"> Worldwide: see table below Warranty: 5 years 	Multimode Fiber (MMF)		Single mode Fiber (SMF)
	OM1 or OM2 62.5/125µm	OM3 or OM4 50/125µm	9/125µm
<p>10 Gigabit SFP+</p>  <ul style="list-style-type: none"> Fits into M4350 SFP+ and SFP28* interfaces 	<p>AXM763</p> <p>10GBase-LRM long reach multimode 802.3aq - LC duplex connector up to 100m (328 ft)</p> <p>AXM763-10000S (1 unit)</p>	<p>AXM763</p> <p>10GBase-LRM long reach multimode 802.3aq - LC duplex connector up to 165m (541 ft)</p> <p>AXM763-10000S (1 unit)</p> <p>AXM761</p> <p>10GBase-SR short reach multimode LC duplex connector up to 300m (984 ft)</p> <p>AXM761-10000S (1 unit) AXM761P10-10000S (pack of 10 units)</p>	<p>AXM762</p> <p>10GBase-LR long reach single mode LC duplex connector up to 10km (6.2 miles)</p> <p>AXM762-10000S (1 unit) AXM762P10-10000S (pack of 10 units)</p> <p>AXM764</p> <p>10GBase-LR LITE single mode LC duplex connector up to 2km (1.2 mile)</p> <p>AXM764-10000S (1 unit)</p>
<p>Gigabit SFP</p>  <ul style="list-style-type: none"> Fits into M4350 SFP+ and SFP28* interfaces 	<p>AGM731F</p> <p>1000Base-SX short range multimode LC duplex connector up to 275m (902 ft)</p> <p>AGM731F (1 unit)</p>	<p>AGM731F</p> <p>1000Base-SX short range multimode LC duplex connector</p> <p>OM3: up to 550m (1,804 ft) OM4: up to 1,000m (3,280 ft)</p> <p>AGM731F (1 unit)</p>	<p>AGM732F</p> <p>1000Base-LX long range single mode LC duplex connector up to 10km (6.2 miles)</p> <p>AGM732F (1 unit)</p>

* ETHERNET Mode: Each 4 x 25G block is connected to a 100G SERDES. As such, each 4-port block can only work at the same speed: 4x1G, or 4x10G, or 4x25G. Since 25G takes precedence, when one 25G module is inserted, other ports with 1G or 10G modules get down in the same 4-port block.

STACKING Mode: Stacking link only works on the highest speed supported by a Stack port. A 25G port, when configured in Stack mode, only operates at 25G. It cannot operate at 10G. Similarly, a 100G port, when configured in Stack mode, only operates at 100G.

<p>AGM734 1000BASE-T RJ45 SFP (Gigabit)</p>	<p>Ordering information</p> <ul style="list-style-type: none"> Worldwide: AGM734-10000S Warranty: 5 years 		<ul style="list-style-type: none"> Fits into M4350 SFP+ and SFP28* interfaces 1 port Gigabit RJ45 Supports only 1000Mbps full-duplex mode Up to 100m (328 ft) with Cat5 RJ45 or better Conveniently adds 1G copper connectivity to M4350 fiber interfaces
<p>AXM765 10GBASE-T RJ45 SFP+ (10 Gigabit)</p>	<p>Ordering information</p> <ul style="list-style-type: none"> Worldwide: AXM765-20000S Warranty: 5 years 		<ul style="list-style-type: none"> Fits into M4350 SFP+ and SFP28* interfaces 1 port 10GBASE-T RJ45 Copper connectivity up to 80m (262 ft) distance CAT6a or better wiring required for 10GBASE-T up to 80 meters Conveniently adds 10G copper connectivity to M4350 fiber interfaces

Accessories

Direct Attach Cables for M4350 series

ORDERING INFORMATION WORLDWIDE: SEE TABLE BELOW WARRANTY: 5 YEARS	SFP+ to SFP+		
	1 meter (3.3 ft)	3 meters (9.8 ft)	5 meters (16.4 ft)
<p>10 Gigabit DAC</p>  <ul style="list-style-type: none"> • Fits into M4350 SFP+ and SFP28* interfaces 	<p>AXC761 10GSFP+ Cu (passive) SFP+ connectors</p> <p>AXC761-10000S (1 unit)</p>	<p>AXC763 10GSFP+ Cu (passive) SFP+ connectors</p> <p>AXC763-10000S (1 unit)</p>	<p>AXC765 10GSFP+ Cu (active) SFP+ connectors</p> <p>AXC765-10000S (1 unit)</p>
	7 meters (23.0 ft)	10 meters (32.8 ft)	15 meters (49.2 ft)
	<p>AXC767 10GSFP+ Cu (active) SFP+ connectors</p> <p>AXC767-10000S (1 unit)</p>	<p>AXC7610 10GSFP+ Cu (active) SFP+ connectors</p> <p>AXC7610-10000S (1 unit)</p>	<p>AXC7615 10GSFP+ (duplex fiber optic) SFP+ connectors</p> <p>AXC7615-10000S (1 unit)</p>
	20 meters (65.6 ft)		
	<p>AXC7620 10GSFP+ (duplex fiber optic) SFP+ connectors</p> <p>AXC7620-10000S (1 unit)</p>		

* ETHERNET Mode: Each 4 x 25G block is connected to a 100G SERDES. As such, each 4-port block can only work at the same speed: 4x1G, or 4x10G, or 4x25G. Since 25G takes precedence, when one 25G module is inserted, other ports with 1G or 10G modules get down in the same 4-port block.

STACKING Mode: Stacking link only works on the highest speed supported by a Stack port. A 25G port, when configured in Stack mode, only operates at 25G. It cannot operate at 10G. Similarly, a 100G port, when configured in Stack mode, only operates at 100G.

Technical Specifications

Requirements based on 14.0 software release



Model Name	Description	Model number	
M4350-24G4XF	24x1G PoE+ and 4xSFP+ (648W base, up to 720W)	GSM4328	
M4350-48G4XF	48x1G PoE+ and 4xSFP+ (236W base, up to 1,440W)	GSM4352	
M4350-44M4X4V	44x2.5G, 4x10G/Multi-Gig PoE++ and 4xSFP28 25G (194W base, up to 3,314W)	MSM4352	
M4350-8X8F	Half-Width 8x10G/Multi-Gig and 8xSFP+	XSM4316	
M4350-12X12F	Half-Width 12x10G/Multi-Gig and 12xSFP+	XSM4324	
M4350-24X4V	24x10G/Multi-Gig PoE+ and 4xSFP28 25G (576W base, up to 720W)	XSM4328CV	
M4350-24F4V	24xSFP+ and 4xSFP28 25G	XSM4328FV	
M4350-36X4V	36x10G/Multi-Gig PoE++ and 4xSFP28 25G (280W base, up to 1,760W)	XSM4340CV	
M4350-24X8F8V	24x10G/Multi-Gig PoE++, 8xSFP+ and 8xSFP28 25G (290W base, up to 1,770W)	XSM4340V	
M4350-32F8V	32xSFP+ and 8xSFP28 25G	XSM4340FV	
M4350-16V4C	16xSFP28 25G and 4xQSFP28 100G	VSM4320C	
M4350-40X4C	40x10G/Multi-Gig PoE++ and 4xQSFP28 100G (196W base, up to 1,676W)	XSM4344C	
APS350W	350W Power Supply Unit	For M4350-24G4XF (GSM4328); M4350-48G4XF (GSM4352); M4350-44M4X4V (MSM4352); M4350-24X4V (XSM4328CV); M4350-24F4V (XSM4328FV)	APS350W-100NES/AJS/00S
APS600Wv2	600W Power Supply Unit		APS600W-200NES/AJS/00S
APS920W	920W Power Supply Unit		APS920W-100NES/AJS/00S
APS2000W	2,000W Power Supply Unit		APS2000W-100NES/AJS/00S
APS600Wv3	600W Power Supply Unit	For M4350-36X4V (XSM4340CV); M4350-24X8F8V (XSM4340V); M4350-32F8V (XSM4340FV); M4350-16V4C (VSM4320C); M4350-40X4C (XSM4344C)	APS600W-300NES/AJS/00S
APS1200Wv2	1,200W Power Supply Unit		APS1200W-200NES/AJS/00S
APS2000Wv2	2,000W Power Supply Unit		APS2000W-200NES/AJS/00S

Technical Specifications

Physical Interfaces						
I/O Ports	Auto-sensing RJ45 10/100/1000BASE-T	Auto-sensing RJ45 100/1000/2.5GBASE-T	Auto-sensing RJ45 100/1000/2.5/5/10GBASE-T	Auto-sensing SFP+ 1000/10GBASE-X	Auto-sensing SFP28 1000/10G/25GBASE-X	Auto-sensing QSFP28 40G/100GBASE-X
M4350-24G4XF (GSM4328)	24 ports PoE+ 648W (base) up to 720W	-	-	4 ports	-	-
M4350-48G4XF (GSM4352)	48 ports PoE+ 236W (base) up to 1,440W	-	-	4 ports	-	-
M4350-44M4X4V (MSM4352)	-	44 ports PoE++ <---194W (base) up to 3,314W --->	4 ports PoE++ 1000/2.5/5/10G only no 100M support	-	4 ports Ethernet mode: 10G/25G*; Stacking mode: 25G**	-
M4350-8X8F (XSM4316)	-	-	8 ports	8 ports 1G only on ports 9-12	-	-
M4350-12X12F (XSM4324)	-	-	12 ports	12 ports 1G only on ports 13-20	-	-
M4350-24X4V (XSM4328CV)	-	-	24 ports PoE+ 100M only on ports 1-16 576W (base) up to 720W	-	4 ports Ethernet mode: 10G/25G*; Stacking mode: 25G**	-
M4350-24F4V (XSM4328FV)	-	-	-	24 ports 1G only on ports 1-16	4 ports Ethernet mode: 10G/25G*; Stacking mode: 25G**	-
M4350-36X4V (XSM4340CV)	-	-	36 ports PoE++ 100M only on ports 1-28 280W (base) up to 1,760W	-	4 ports Ethernet mode: 10G/25G*; Stacking mode: 25G**	-
M4350-24X8F8V (XSM4340V)	-	-	24 ports PoE++ 290W (base) up to 1,770W	8 ports 1G only on ports 25-28	8 ports Ethernet mode: 10G/25G*; Stacking mode: 25G**	-
M4350-32F8V (XSM4340FV)	-	-	-	32 ports 1G only on ports 1-28	8 ports Ethernet mode: 10G/25G*; Stacking mode: 25G**	-
M4350-16V4C (VSM4320C)	-	-	-	-	16 ports Ethernet mode: 10G/25G*; Stacking mode: 25G**	4 ports Ethernet mode: 40G/100G/4x25G Breakout; Stacking Mode: 100G**
M4350-40X4C (XSM4344C)	-	-	40 ports PoE++ 1000/2.5/5/10G only no 100M support 196W (base) up to 1,676W	-	-	4 ports Ethernet mode: 40G/100G/4x25G Breakout; Stacking Mode: 100G**

Technical Specifications

Total Usable Port Count	1G Ports	2.5G ports	10G ports	25G ports	100G ports
M4350-24G4XF	24	-	4	-	-
M4350-48G4XF	48	-	4	-	-
M4350-44M4X4V	-	44	4	4	-
M4350-8X8F	-	-	16	-	-
M4350-12X12F	-	-	24	-	-
M4350-24X4V; M4350-24F4V	-	-	24	4	-
M4350-36X4V	-	-	36	4	-
M4350-24X8F8V; M4350-32F8V	-	-	32	8	-
M4350-16V4C	-	-	-	16	4
M4350-40X4C	-	-	40	-	4
Management Ports	Console port	Service port (Out-of-band Ethernet)		Storage ports	
All models	USB-C (front)	1 x RJ45 10/100/1000BASE-T (back)		2 x USB-A (back)	

*** Ethernet Mode:** Each 4 x 25G block is connected to a 100G SERDES. As such, each 4-port block can only work at the same speed: 4x10G, or 4x25G. Since 25G takes precedence, when one 25G module is inserted, other ports with 10G modules get down in the same 4-port block.

**** Stacking Mode:** Stacking link only works on the highest speed supported by a Stack port. A 25G port, when configured in Stack mode, only operates at 25G. It cannot operate at 10G. Similarly, a 100G port, when configured in Stack mode, only operates at 100G.

Power Supplies	Internal PSU	General On/Off Switch	Modular PSU Slots	Application with modular PSU (sold separately)	Ordering SKUs
M4350-24G4XF	1 (880W) C14 connector	1	1 slot for APS350W, APS600Wv2, APS920W, or APS2000W		APS350W-100NES/AJS/00S
M4350-48G4XF	1 (550W) C14 connector	1	2 slots for APS350W, APS600Wv2, APS920W, or APS2000W	1+1 RPS, and EPS power sharing simultaneously	APS600W-200NES/AJS/00S
M4350-44M4X4V	1 (550W) C14 connector	1	2 slots for APS350W, APS600Wv2, APS920W, or APS2000W		APS920W-100NES/AJS/00S
M4350-8X8F	1 (240W) C14 connector	1	-	-	APS2000W-100NES/AJS/00S
M4350-12X12F	1 (240W) C14 connector	1	-	-	
M4350-24X4V	1 (880W) C14 connector	1	1 slot for APS350W, APS600Wv2, APS920W, or APS2000W		
M4350-24F4V	1 (240W) C14 connector	1	1 slot for APS350W, APS600Wv2, APS920W, or APS2000W		
M4350-36X4V	1 (750W) C14 connector	1	1 slot for APS600Wv3, APS1200Wv2, or APS2000Wv2		APS600W-300NES/AJS/00S
M4350-24X8F8V	1 (750W) C14 connector	1	1 slot for APS600Wv3, APS1200Wv2, or APS2000Wv2	1+1 RPS, and EPS power sharing simultaneously	APS1200W-200NES/AJS/00S
M4350-32F8V	1 (420W) C14 connector	1	1 slot for APS600Wv3, APS1200Wv2, or APS2000Wv2		APS2000W-200NES/AJS/00S
M4350-16V4C	1 (420W) C14 connector	1	1 slot for APS600Wv3, APS1200Wv2, or APS2000Wv2		
M4350-40X4C	1 (750W) C14 connector	1	1 slot for APS600Wv3, APS1200Wv2, or APS2000Wv2		

Fixed fans	
All models	Front-to-back airflow

Technical Specifications

Power over Ethernet		
PSE Capacity	PoE+ Ports (802.3at)	Ultra90 PoE++ Ports (802.3bt)
M4350-24G4XF	24	-
M4350-48G4XF	48	-
M4350-44M4X4V	-	48
M4350-8X8F	-	-
M4350-12X12F	-	-
M4350-24X4V	24	-
M4350-24F4V	-	-
M4350-36X4V	-	36
M4350-24X8F8V	-	24
M4350-32F8V	-	-
M4350-16V4C	-	-
M4350-40X4C	-	40

Ultra90 PoE++ 802.3bt is compatible with:
802.3af PoE (15.4W), 802.3at PoE++ (30W),
and 802.3bt (60W, 75W and 90W).

PoE Budget and EPS/RPS Wattages	Internal PSU		Modular PSUs		Switch Operational Without PoE?	Available PoE Budget
		PSU Slot 1	PSU Slot 2			
M4350-24G4XF	880W - Connected	Disconnected	-	-	Yes	648W
APS350W-100NES/AJS	880W - Connected	APS350W	-	-	Yes	720W
APS350W-100NES/AJS	Disconnected	APS350W	-	-	Yes	218W
APS600W-200NES/AJS	880W - Connected	APS600Wv2	-	-	Yes	720W
APS600W-200NES/AJS	Disconnected	APS600Wv2	-	-	Yes	468W
APS920W-100NES/AJS	880W - Connected	APS920W	-	-	Yes	720W
APS920W-100NES/AJS	Disconnected	APS920W	-	-	Yes	720W
APS2000W-100NES/AJS	880W - Connected	APS2000W 110VAC	-	-	Yes	720W
APS2000W-100NES/AJS	Disconnected	APS2000W 110VAC	-	-	Yes	720W
APS2000W-100NES/AJS	880W - Connected	APS2000W 220VAC	-	-	Yes	720W
APS2000W-100NES/AJS	Disconnected	APS2000W 220VAC	-	-	Yes	720W

Technical Specifications

	Internal PSU	PSU Slot 1	PSU Slot 2	Operational without PoE?	PoE Budget
M4350-48G4XF	550W - Connected	Disconnected	Disconnected	Yes	236W
APS350W-100NES/AJS	550W - Connected	APS350W	Disconnected	Yes	436W
APS350W-100NES/AJS	Disconnected	APS350W	Disconnected	Yes	186W
APS600W-200NES/AJS	550W - Connected	APS600Wv2	Disconnected	Yes	636W
APS600W-200NES/AJS	Disconnected	APS600Wv2	Disconnected	Yes	436W
APS920W-100NES/AJS	550W - Connected	APS920W	Disconnected	Yes	892W
APS920W-100NES/AJS	Disconnected	APS920W	Disconnected	Yes	756W
APS2000W-100NES/AJS	550W - Connected	APS2000W 110VAC	Disconnected	Yes	956W
APS2000W-100NES/AJS	Disconnected	APS2000W 110VAC	Disconnected	Yes	836W
APS2000W-100NES/AJS	550W - Connected	APS2000W 220VAC	Disconnected	Yes	1,440W
APS2000W-100NES/AJS	Disconnected	APS2000W 220VAC	Disconnected	Yes	1,440W
APS350W-100NES/AJS	550W - Connected	APS350W	APS350W	Yes	716W
APS350W-100NES/AJS	Disconnected	APS350W	APS350W	Yes	396W
APS600W-200NES/AJS	550W - Connected	APS600Wv2	APS600Wv2	Yes	1,116W
APS600W-200NES/AJS	Disconnected	APS600Wv2	APS600Wv2	Yes	796W
APS920W-100NES/AJS	550W - Connected	APS920W	APS920W	Yes	1,440W
APS920W-100NES/AJS	Disconnected	APS920W	APS920W	Yes	1,308W
APS2000W-100NES/AJS	550W - Connected	APS2000W 110VAC	APS2000W 110VAC	Yes	1,440W
APS2000W-100NES/AJS	Disconnected	APS2000W 110VAC	APS2000W 110VAC	Yes	1,436W
APS2000W-100NES/AJS	550W - Connected	APS2000W 220VAC	APS2000W 220VAC	Yes	1,440W
APS2000W-100NES/AJS	Disconnected	APS2000W 220VAC	APS2000W 220VAC	Yes	1,440W

Technical Specifications

	Internal PSU	PSU Slot 1	PSU Slot 2	Operational without PoE?	PoE Budget
M4350-44M4X4V	550W - Connected	Disconnected	Disconnected	Yes	194W
APS350W-100NES/AJS	550W - Connected	APS350W	Disconnected	Yes	394W
APS350W-100NES/AJS	Disconnected	APS350W	Disconnected	Yes	144W
APS600W-200NES/AJS	550W - Connected	APS600Wv2	Disconnected	Yes	594W
APS600W-200NES/AJS	Disconnected	APS600Wv2	Disconnected	Yes	394W
APS920W-100NES/AJS	550W - Connected	APS920W	Disconnected	Yes	850W
APS920W-100NES/AJS	Disconnected	APS920W	Disconnected	Yes	714W
APS2000W-100NES/AJS	550W - Connected	APS2000W 110VAC	Disconnected	Yes	914W
APS2000W-100NES/AJS	Disconnected	APS2000W 110VAC	Disconnected	Yes	794W
APS2000W-100NES/AJS	550W - Connected	APS2000W 220VAC	Disconnected	Yes	1,714W
APS2000W-100NES/AJS	Disconnected	APS2000W 220VAC	Disconnected	Yes	1,794W
APS350W-100NES/AJS	550W - Connected	APS350W	APS350W	Yes	674W
APS350W-100NES/AJS	Disconnected	APS350W	APS350W	Yes	354W
APS600W-200NES/AJS	550W - Connected	APS600Wv2	APS600Wv2	Yes	1,074W
APS600W-200NES/AJS	Disconnected	APS600Wv2	APS600Wv2	Yes	754W
APS920W-100NES/AJS	550W - Connected	APS920W	APS920W	Yes	1,586W
APS920W-100NES/AJS	Disconnected	APS920W	APS920W	Yes	1,266W
APS2000W-100NES/AJS	550W - Connected	APS2000W 110VAC	APS2000W 110VAC	Yes	1,714W
APS2000W-100NES/AJS	Disconnected	APS2000W 110VAC	APS2000W 110VAC	Yes	1,394W
APS2000W-100NES/AJS	550W - Connected	APS2000W 220VAC	APS2000W 220VAC	Yes	3,314W
APS2000W-100NES/AJS	Disconnected	APS2000W 220VAC	APS2000W 220VAC	Yes	2,994W

Technical Specifications

	Internal PSU	PSU Slot 1	PSU Slot 2	Operational without PoE?	PoE Budget
M4350-24X4V	880W - Connected	Disconnected	-	Yes	576W
APS350W-100NES/AJS	880W - Connected	APS350W	-	Yes	700W
APS350W-100NES/AJS	Disconnected	APS350W	-	Yes	146W
APS600W-200NES/AJS	880W - Connected	APS600Wv2	-	Yes	720W
APS600W-200NES/AJS	Disconnected	APS600Wv2	-	Yes	396W
APS920W-100NES/AJS	880W - Connected	APS920W	-	Yes	720W
APS920W-100NES/AJS	Disconnected	APS920W	-	Yes	716W
APS2000W-100NES/AJS	880W - Connected	APS2000W 110VAC	-	Yes	720W
APS2000W-100NES/AJS	Disconnected	APS2000W 110VAC	-	Yes	720W
APS2000W-100NES/AJS	880W - Connected	APS2000W 220VAC	-	Yes	720W
APS2000W-100NES/AJS	Disconnected	APS2000W 220VAC	-	Yes	720W
	Internal PSU	PSU Slot 1	PSU Slot 2	Operational without PoE?	PoE Budget
M4350-24F4V	240W - Connected	Disconnected	-	Yes	-
APS350W-100NES/AJS	240W - Connected	APS350W	-	Yes	-
APS350W-100NES/AJS	Disconnected	APS350W	-	Yes	-
APS600W-200NES/AJS	240W - Connected	APS600Wv2	-	Yes	-
APS600W-200NES/AJS	Disconnected	APS600Wv2	-	Yes	-
APS920W-100NES/AJS	240W - Connected	APS920W	-	Yes	-
APS920W-100NES/AJS	Disconnected	APS920W	-	Yes	-
APS2000W-100NES/AJS	240W - Connected	APS2000W 110VAC	-	Yes	-
APS2000W-100NES/AJS	Disconnected	APS2000W 110VAC	-	Yes	-
APS2000W-100NES/AJS	240W - Connected	APS2000W 220VAC	-	Yes	-
APS2000W-100NES/AJS	Disconnected	APS2000W 220VAC	-	Yes	-

Technical Specifications

	Internal PSU	PSU Slot 1	PSU Slot 2	Operational without PoE?	PoE Budget
M4350-36X4V	750W - Connected	Disconnected	-	Yes	280W
APS600W-300NES/AJS	750W - Connected	APS600Wv3	-	Yes	640W
APS600W-300NES/AJS	Disconnected	APS600Wv3	-	Yes	280W
APS1200W-200NES/AJS	750W - Connected	APS1200Wv2 110VAC	-	Yes	960W
APS1200W-200NES/AJS	Disconnected	APS1200Wv2 110VAC	-	Yes	680W
APS1200W-200NES/AJS	750W - Connected	APS1200Wv2 220VAC	-	Yes	1,120W
APS1200W-200NES/AJS	Disconnected	APS1200Wv2 220VAC	-	Yes	880W
APS2000W-200NES/AJS	750W - Connected	APS2000Wv2 110VAC	-	Yes	960W
APS2000W-200NES/AJS	Disconnected	APS2000Wv2 110VAC	-	Yes	680W
APS2000W-200NES/AJS	750W - Connected	APS2000Wv2 220VAC	-	Yes	1,760W
APS2000W-200NES/AJS	Disconnected	APS2000Wv2 220VAC	-	Yes	1,680W
	Internal PSU	PSU Slot 1	PSU Slot 2	Operational without PoE?	PoE Budget
M4350-24X8F8V	750W - Connected	Disconnected	-	Yes	290W
APS600W-300NES/AJS	750W - Connected	APS600Wv3	-	Yes	650W
APS600W-300NES/AJS	Disconnected	APS600Wv3	-	Yes	290W
APS1200W-200NES/AJS	750W - Connected	APS1200Wv2 110VAC	-	Yes	970W
APS1200W-200NES/AJS	Disconnected	APS1200Wv2 110VAC	-	Yes	690W
APS1200W-200NES/AJS	750W - Connected	APS1200Wv2 220VAC	-	Yes	1,130W
APS1200W-200NES/AJS	Disconnected	APS1200Wv2 220VAC	-	Yes	890W
APS2000W-200NES/AJS	750W - Connected	APS2000Wv2 110VAC	-	Yes	970W
APS2000W-200NES/AJS	Disconnected	APS2000Wv2 110VAC	-	Yes	690W
APS2000W-200NES/AJS	750W - Connected	APS2000Wv2 220VAC	-	Yes	1,770W
APS2000W-200NES/AJS	Disconnected	APS2000Wv2 220VAC	-	Yes	1,690W

Technical Specifications

	Internal PSU	PSU Slot 1	PSU Slot 2	Operational without PoE?	PoE Budget
M4350-32F8V	420W - Connected	Disconnected	-	Yes	-
APS600W-300NES/AJS	420W - Connected	APS600Wv3	-	Yes	-
APS600W-300NES/AJS	Disconnected	APS600Wv3	-	Yes	-
APS1200W-200NES/AJS	420W - Connected	APS1200Wv2 110VAC	-	Yes	-
APS1200W-200NES/AJS	Disconnected	APS1200Wv2 110VAC	-	Yes	-
APS1200W-200NES/AJS	420W - Connected	APS1200Wv2 220VAC	-	Yes	-
APS1200W-200NES/AJS	Disconnected	APS1200Wv2 220VAC	-	Yes	-
APS2000W-200NES/AJS	420W - Connected	APS2000Wv2 110VAC	-	Yes	-
APS2000W-200NES/AJS	Disconnected	APS2000Wv2 110VAC	-	Yes	-
APS2000W-200NES/AJS	420W - Connected	APS2000Wv2 220VAC	-	Yes	-
APS2000W-200NES/AJS	Disconnected	APS2000Wv2 220VAC	-	Yes	-
	Internal PSU	PSU Slot 1	PSU Slot 2	Operational without PoE?	PoE Budget
M4350-16V4C	420W - Connected	Disconnected	-	Yes	-
APS600W-300NES/AJS	420W - Connected	APS600Wv3	-	Yes	-
APS600W-300NES/AJS	Disconnected	APS600Wv3	-	Yes	-
APS1200W-200NES/AJS	420W - Connected	APS1200Wv2 110VAC	-	Yes	-
APS1200W-200NES/AJS	Disconnected	APS1200Wv2 110VAC	-	Yes	-
APS1200W-200NES/AJS	420W - Connected	APS1200Wv2 220VAC	-	Yes	-
APS1200W-200NES/AJS	Disconnected	APS1200Wv2 220VAC	-	Yes	-
APS2000W-200NES/AJS	420W - Connected	APS2000Wv2 110VAC	-	Yes	-
APS2000W-200NES/AJS	Disconnected	APS2000Wv2 110VAC	-	Yes	-
APS2000W-200NES/AJS	420W - Connected	APS2000Wv2 220VAC	-	Yes	-
APS2000W-200NES/AJS	Disconnected	APS2000Wv2 220VAC	-	Yes	-
	Internal PSU	PSU Slot 1	PSU Slot 2	Operational without PoE?	PoE Budget
M4350-40X4C	750W - Connected	Disconnected	-	Yes	196W
APS600W-300NES/AJS	750W - Connected	APS600Wv3	-	Yes	556W
APS600W-300NES/AJS	Disconnected	APS600Wv3	-	Yes	196W
APS1200W-200NES/AJS	750W - Connected	APS1200Wv2 110VAC	-	Yes	876W
APS1200W-200NES/AJS	Disconnected	APS1200Wv2 110VAC	-	Yes	596W
APS1200W-200NES/AJS	750W - Connected	APS1200Wv2 220VAC	-	Yes	1,036W
APS1200W-200NES/AJS	Disconnected	APS1200Wv2 220VAC	-	Yes	796W
APS2000W-200NES/AJS	750W - Connected	APS2000Wv2 110VAC	-	Yes	876W
APS2000W-200NES/AJS	Disconnected	APS2000Wv2 110VAC	-	Yes	596W
APS2000W-200NES/AJS	750W - Connected	APS2000Wv2 220VAC	-	Yes	1,676W
APS2000W-200NES/AJS	Disconnected	APS2000Wv2 220VAC	-	Yes	1,596W

Technical Specifications

PoE Features Support	M4350-24G4XF (GSM4328) M4350-48G4XF (GSM4352) M4350-24X4V (XSM4328CV)		M4350-44M4X4V (MSM4352) M4350-36X4V (XSM4340CV) M4350-24X8F8V (XSM4340V) M4350-40X4C (XSM4344C)	
IEEE 802.3af (up to 15.4W per port)	Yes		Yes	
IEEE 802.3at (up to 30W per port)	Yes		Yes	
IEEE 802.3bt (up to 90W per port)	No		Yes	
IEEE 802.3at Layer 2 (LLDP) method	Yes		Yes	
IEEE 802.3at 2-event classification	Yes		Yes	
IEEE 802.3bt Layer 2 (LLDP) method	No		Yes	
IEEE 802.3bt auto-classification method	No		Yes	
Pre-802.3bt standard method	No		Yes	
PoE timer / schedule (week, days, hours)	Yes		Yes	
Processor/Memory	M4350-24G4XF	M4350-48G4XF; M4350-44M4X4V M4350-8X8F; M4350-12X12F M4350-24X4V; M4350-24F4V	M4350-36X4V; M4350-24X8F8V M4350-32F8V;	M4350-16V4C M4350-40X4C
Processor (CPU)	Quad-Core Cortex-A57 ARMv8 1.8Ghz 64-bit	Quad-Core Cortex-A57 ARMv8 1.8Ghz 64-bit	Quad-Core Cortex-A57 ARMv8 1.8Ghz 64-bit	Quad-Core Cortex-A57 ARMv8 1.8Ghz 64-bit
System memory (RAM)	2GB RAM DDR4	2GB RAM DDR4	4GB RAM DDR4	4GB RAM DDR4
Code storage (flash)	512MB NAND 8-bit ECC	512MB NAND 8-bit ECC	512MB NAND 8-bit ECC	512MB NAND 8-bit ECC
Packet Buffer Memory	16Mb	32Mb	64Mb	256Mb

Technical Specifications

Virtual Chassis Stacking	
Max physical switches per stack, at the edge	8
Max physical switches per stack, at the core	2
Mixed stacking table size	Mixed stacking SDM template is used based on "least common denominator" set of capacities
Stack ports (pre-configuration)	No pre-configured stacking port: any 100G, 25G, or 10G port and any media type can be used for stacking
Stack ports (max number)	1G models: up to 4 (10G) ports per switch 10G models and up: up to 16 ports (10G, 25G, 100G) per switch
Stack ports (max speed limitation)	Stacking link only works on the highest speed supported by a Stack port. A 25G port, when configured in Stack mode, only operates at 25G - it cannot operate at 10G. Similarly, a 100G port, when configured in Stack mode, only operates at 100G.
Stacking limitation (mutually exclusive features)	Stacking, AVB, and PTP TC are mutually exclusive features: M4350 stack cannot run AVB, nor PTP TC (or BC/GM)
Vertical and horizontal stacking topologies	Chain, single ring, dual ring, mesh, double star
Distant stacking using fiber	Yes
Non-stop forwarding (NSF)	Yes
Hitless management unit failover and failback	Yes, no service interruption across the stack
Automatic unit replacement (AUR)	Yes
Distributed Link Aggregation (LAGs across the stack)	Yes
Stack with M4300 switches	Not supported, only M4350 models

Technical Specifications

Performance Summary

Switching fabric

M4350-24G4XF	128 Gbps
M4350-48G4XF	176 Gbps
M4350-44M4X4V	500 Gbps
M4350-8X8F	320 Gbps
M4350-12X12F	480 Gbps
M4350-24X4V; M4350-24F4V	680 Gbps
M4350-36X4V	920 Gbps
M4350-24X8F8V; M4350-32F8V	1.04 Tbps
M4350-16V4C; M4350-40X4C	1.6 Tbps

Throughput (64-byte frames)

M4350-24G4XF	95.23 Mpps
M4350-48G4XF	130.94 Mpps
M4350-44M4X4V	372 Mpps
M4350-8X8F	238.08 Mpps
M4350-12X12F	357.12 Mpps
M4350-24X4V; M4350-24F4V	505.92 Mpps
M4350-36X4V	684.48 Mpps
M4350-24X8F8V; M4350-32F8V	773.76 Mpps
M4350-16V4C; M4350-40X4C	1190.4 Mpps

Technical Specifications

Latency - 10G Fiber	64-byte frames	512-byte frames	1024-byte frames	1518-byte frames
M4350-24G4XF	0.916µs	0.884µs	0.869µs	0.871µs
M4350-48G4XF	0.691µs	0.698µs	0.694µs	0.686µs
M4350-44M4X4V	0.72µs	0.731µs	0.734µs	0.729µs
M4350-8X8F	0.826µs	0.852µs	0.878µs	0.849µs
M4350-12X12F	0.713µs	0.746µs	0.78µs	0.744µs
M4350-24X4V	0.644µs	0.659µs	0.668µs	0.655µs
M4350-24F4V	0.629µs	0.662µs	0.689µs	0.661µs
M4350-36X4V	1.297µs	1.304µs	1.296µs	1.3µs
M4350-24X8F8V	1.275µs	1.287µs	1.27µs	1.306µs
M4350-32F8V	1.271µs	1.29µs	1.266µs	1.304µs
M4350-16V4C	1.336µs	1.43µs	1.395µs	1.418µs
M4350-40X4C	1.292µs	1.292µs	1.283µs	1.295µs
Latency - 10G Copper	64-byte frames	512-byte frames	1024-byte frames	1518-byte frames
M4350-24G4XF	-	-	-	-
M4350-48G4XF	-	-	-	-
M4350-44M4X4V	2.27µs	2.3µs	2.337µs	2.298µs
M4350-8X8F	2.384µs	2.405µs	2.432µs	2.401µs
M4350-12X12F	2.281µs	2.309µs	2.344µs	2.307µs
M4350-24X4V	2.201µs	2.24µs	2.284µs	2.238µs
M4350-24F4V	-	-	-	-
M4350-36X4V	2.746µs	2.78µs	2.755µs	2.785µs
M4350-24X8F8V	2.7µs	2.726µs	2.721µs	2.727µs
M4350-32F8V	-	-	-	-
M4350-16V4C	-	-	-	-
M4350-40X4C	2.711µs	2.741µs	2.737µs	2.744µs

Technical Specifications

Latency - 1G Fiber	64-byte frames	512-byte frames	1024-byte frames	1518-byte frames
M4350-24G4XF	2.118µs	2.119µs	2.098µs	2.091µs
M4350-48G4XF	1.062µs	1.059µs	1.065µs	1.09µs
M4350-44M4X4V	1.332µs	1.376µs	1.362µs	1.384µs
M4350-8X8F	1.01µs	1.033µs	1.033µs	1.034µs
M4350-12X12F	1.041µs	1.068µs	1.065µs	1.096µs
M4350-24X4V	1.185µs	1.213µs	1.194µs	1.214µs
M4350-24F4V	1.06µs	1.096µs	1.098µs	1.087µs
M4350-36X4V	-	-	-	-
M4350-24X8F8V	-	-	-	-
M4350-32F8V	-	-	-	-
M4350-16V4C	-	-	-	-
M4350-40X4C	-	-	-	-
Latency - 1G Copper	64-byte frames	512-byte frames	1024-byte frames	1518-byte frames
M4350-24G4XF	2.417µs	2.416µs	2.417µs	2.402µs
M4350-48G4XF	2.194µs	2.418µs	2.547µs	2.432µs
M4350-44M4X4V	2.631µs	2.837µs	2.955µs	2.842µs
M4350-8X8F	2.274µs	2.278µs	2.279µs	2.285µs
M4350-12X12F	2.14µs	2.204µs	2.188µs	2.187µs
M4350-24X4V	2.428µs	2.466µs	2.475µs	2.477µs
M4350-24F4V	-	-	-	-
M4350-36X4V	2.54µs	2.551µs	2.514µs	2.556µs
M4350-24X8F8V	2.503µs	2.46µs	2.454µs	2.453µs
M4350-32F8V	-	-	-	-
M4350-16V4C	-	-	-	-
M4350-40X4C	2.496µs	2.49µs	2.485µs	2.494µs

Technical Specifications

Latency - 2.5G Copper	64-byte frames	512-byte frames	1024-byte frames	1518-byte frames
M4350-24G4XF	-	-	-	-
M4350-48G4XF	-	-	-	-
M4350-44M4X4V	5.607µs	5.877µs	5.977µs	5.869µs
M4350-8X8F	5.581µs	5.603µs	5.601µs	5.623µs
M4350-12X12F	5.475µs	5.522µs	5.523µs	5.529µs
M4350-24X4V	5.278µs	5.344µs	5.341µs	5.344µs
M4350-24F4V	-	-	-	-
M4350-36X4V	5.801µs	5.801µs	5.808µs	5.826µs
M4350-24X8F8V	5.782µs	5.77µs	5.806µs	5.819µs
M4350-32F8V	-	-	-	-
M4350-16V4C	-	-	-	-
M4350-40X4C	5.716µs	5.73µs	5.737µs	5.755µs
Latency - 25G	64-byte frames	512-byte frames	1024-byte frames	1518-byte frames
M4350-24G4XF	-	-	-	-
M4350-48G4XF	-	-	-	-
M4350-44M4X4V	0.748µs	0.761µs	0.773µs	0.759µs
M4350-8X8F	-	-	-	-
M4350-12X12F	-	-	-	-
M4350-24X4V	0.97µs	0.98µs	1µs	0.99µs
M4350-24F4V	0.67µs	0.671µs	0.691µs	0.676µs
M4350-36X4V	1.08µs	1.097µs	1.084µs	1.099µs
M4350-24X8F8V	1.087µs	1.092µs	1.088µs	1.101µs
M4350-32F8V	1.08µs	1.096µs	1.09µs	1.1µs
M4350-16V4C	1.08µs	1.226µs	1.224µs	1.229µs
M4350-40X4C	1.08µs	1.097µs	1.084µs	1.099µs

Technical Specifications

Latency - 100G	64-byte frames	512-byte frames	1024-byte frames	1518-byte frames
M4350-24G4XF	-	-	-	-
M4350-48G4XF	-	-	-	-
M4350-44M4X4V	-	-	-	-
M4350-8X8F	-	-	-	-
M4350-12X12F	-	-	-	-
M4350-24X4V	-	-	-	-
M4350-24F4V	-	-	-	-
M4350-36X4V	-	-	-	-
M4350-24X8F8V	-	-	-	-
M4350-32F8V	-	-	-	-
M4350-16V4C	1.134µs	1.139µs	1.14µs	1.141µs
M4350-40X4C	1.042µs	1.046µs	1.047µs	1.049µs

Green Ethernet

Energy Efficient Ethernet (EEE) Compliant with IEEE 802.3az Energy Efficient Ethernet Task Force Deactivated by default



Technical Specifications

Other Metrics		
Forwarding mode	Store-and-forward	
Addressing	48-bit MAC address	
Address database size	16K MAC addresses	
Number of VLANs	4,093 VLANs (802.1Q) simultaneously	
Number of multicast groups filtered (IGMP)	4K total (2,048 IPv4 and 2,048 IPv6)	
Number of Link Aggregation Groups (LAGs)	64 LAGs with up to 8 ports per group	802.3ad / 802.1AX-2008
Number of hardware queues for QoS (Standalone)	8 queues	
Number of hardware queues for QoS (Stack)	7 queues	
Number of routes		
	IPv4 - Default	894 IPv4 Unicast Routes in IPv4 Basic Default SDM Template
	IPv6 - Default	126 IPv6 Unicast Routes in IPv4 Basic Default SDM Template
	IPv4 - Other Template	10K IPv4 Unicast Routes in IPv4 Basic Plus SDM Template
	IPv6 - Other Template	2K IPv6 Unicast Routes in IPv4 Basic Plus SDM Template
SDM (System Data Management, or switch database) templates allow for granular system resources distribution depending on IPv4 or IPv6 applications		
Number of static routes		
	IPv4	256
	IPv6	64
RIP application route scaling		
	IPv4	512
OSPF application route scaling		
	IPv4	1,024
	IPv6	256
Number of IP routing interfaces (port or VLAN)	128	
Jumbo frame support	up to 12KB packet size	
Acoustic noise (ANSI-S10.12)		
	@ 25 °C ambient (77 °F)	
Testing method	Following the ISO-7779 standard. Bystander Mode. Chamber Temp 25°C during testing unless noted otherwise. Full, 100%, Data and PoE loaded. Worst case.	
SPL (Sound Pressure Level)	dBA values are SPL (Sound Pressure Level) values, testing following the ISO-7779 standard	
Fan management	Two modes are configurable using the AV GUI or the CLI: Quiet mode (default, lowering the noise), and Cool mode (lowering heat)	

Technical Specifications

Quiet mode setting at 25°C ambient and max ambient	PoE Power Load	Fan Duty	Ambient	Case Temp (Top)	Acoustic
M4350-24G4XF	720W	28	25°C	33.1°C	33dBA
	720W	60	45°C	48.2°C	52dBA
M4350-48G4XF	1,440W	28	25°C	33.4°C	33dBA
	1,440W	60	45°C	48.5°C	52dBA
M4350-44M4X4V	3,314W	28	25°C	43.3°C	34dBA
	3,314W	60	45°C	50.1°C	52dBA
M4350-8X8F	N/A	27	25°C	34.4°C	34.43dBA
	N/A	70	50°C	51.7°C	56.3dBA
M4350-12X12F	N/A	27	25°C	31.9°C	34.34dBA
	N/A	100	50°C	51.5°C	64dBA
M4350-24X4V	720W	30	25°C	32.3°C	34.7dBA
	720W	70	45°C	46.6°C	57.2dBA
M4350-24F4V	N/A	30	25°C	34.2°C	34.2dBA
	N/A	85	50°C	52.4°C	61.8dBA
M4350-36X4V	1,760W	25	25°C	39°C	32.1dBA
	1,760W	60	45°C	49.2°C	54dBA
M4350-24X8F8V	1,770W	25	25°C	39.9°C	32.6dBA
	1,770W	60	45°C	48.5°C	53.3dBA
M4350-32F8V	N/A	25	25°C	35°C	32.7dBA
	N/A	80	50°C	52.1°C	63dBA
M4350-16V4C	N/A	28	25°C	38.2°C	36.4dBA
	N/A	60	45°C	56°C	55dBA
M4350-40X4C	1676W	25	25°C	39.9°C	34.1dBA
	1676W	60	45°C	49.6°C	54.3dBA

For QUIET MODE, Min conditions are:
 Lowest fan duty when ambient temperature is 25°C,
 all ports used,
 max traffic,
 max PoE budget (additional PSUs).
 Worst case.

For QUIET MODE, Max conditions are:
 Highest fan duty when ambient temperature is 45°C
 (PoE models) or 50°C (non-PoE models),
 all ports used,
 max traffic,
 max PoE budget (additional PSUs) (if applicable).
 Worst case.

Technical Specifications

Cool mode setting at 25°C ambient	Fan Duty	Case Temp (Top)	Acoustic
M4350-24G4XF	60	31.9°C	52dBA
M4350-48G4XF	60	31.3°C	52dBA
M4350-44M4X4V	60	38.3°C	52dBA
M4350-8X8F	70	30.3°C	56.3dBA
M4350-12X12F	100	29.5°C	64dBA
M4350-24X4V	70	29.6°C	57.2dBA
M4350-24F4V	85	30.3°C	61.8dBA
M4350-36X4V	60	30.4°C	54dBA
M4350-24X8F8V	60	31°C	53.3dBA
M4350-32F8V	80	28.9°C	63dBA
M4350-16V4C	60	30.8°C	55dBA
M4350-40X4C	60	33.9°C	54.3dBA

Heat Dissipation (BTU) based on max power consumption	Switch idle standby, without any port connection	All ports connected full mesh traffic, without PoE	All ports connected full mesh, full PoE, internal PSU	All ports connected full mesh, max PoE budget, modular PSUs
M4350-24G4XF	32W - 109.19 BTU/hr	80W - 272.97 BTU/hr	792.1W - 2702.76 BTU/hr	871.2W - 2972.73BTU/hr
M4350-48G4XF	48.5W - 165.49 BTU/hr	99W - 337.8 BTU/hr	348W - 1187.43 BTU/hr	1618.3W - 5521.94BTU/hr
M4350-44M4X4V	56.5W - 192.79 BTU/hr	133.5W - 455.52 BTU/hr	351.5W - 1199.37 BTU/hr	3857.5W - 13162.27BTU/hr
M4350-8X8F	30.5W - 104.07 BTU/hr	81.1W - 276.72 BTU/hr	-	-
M4350-12X12F	34W - 116.01 BTU/hr	95.8W - 326.88 BTU/hr	-	-
M4350-24X4V	53.6W - 182.89 BTU/hr	119.4W - 407.41 BTU/hr	750.1W - 2559.45 BTU/hr	907.8W - 3097.46BTU/hr
M4350-24F4V	45.2W - 154.23 BTU/hr	119.3W - 407.07 BTU/hr	-	-
M4350-36X4V	59.3W - 202.34 BTU/hr	148W - 505 BTU/hr	454W - 1549.11 BTU/hr	2071.4W - 7068.01BTU/hr
M4350-24X8F8V	53.4W - 182.21 BTU/hr	151.8W - 517.96 BTU/hr	464W - 1583.23 BTU/hr	2057.3W - 7019.79BTU/hr
M4350-32F8V	42.6W - 145.36 BTU/hr	156.4W - 533.66 BTU/hr	-	-
M4350-16V4C	60.4W - 206.09 BTU/hr	143.4W - 489.3 BTU/hr	-	-
M4350-40X4C	98.8W - 337.12 BTU/hr	200.4W - 683.79 BTU/hr	413W - 1409.21 BTU/hr	2018.3W - 6886.89BTU/hr

Technical Specifications

Mean Time Between Failures (MTBF)	@ 25 °C ambient (77 °F)	@ 45°C ambient (113 °F)	@ 50 °C ambient (122 °F)
M4350-24G4XF	782,376 hours (~89.3 years)	381,957 hours (~43.6 years)	-
M4350-48G4XF	623,591 hours (~71.2 years)	322,725 hours (~36.8 years)	-
M4350-44M4X4V	320,552 hours (~36.6 years)	213,173 hours (~24.3 years)	-
M4350-8X8F	1,101,630 hours (~116.2 years)	-	676,880 hours (~77.3 years)
M4350-12X12F	780,202 hours (~89.1 years)	-	379,906 hours (~43.4 years)
M4350-24X4V	486,832 hours (~55.6 years)	383,579 hours (~43.8 years)	-
M4350-24F4V	778,741 hours (~88.9 years)	-	354,995 hours (~40.5 years)
M4350-36X4V	292,505 hours (~33.3 years)	264,032 hours (~30.1 years)	-
M4350-24X8F8V	386,078 hours (~44.1 years)	288,778 hours (~32.9years)	-
M4350-32F8V	582,420 hours (~66.4 years)	-	274,403 hours (~31.3 years)
M4350-16V4C	518,782 hours (~59.2years)	-	260,575 hours (~29.7 years)
M4350-40X4C	229,375 hours (~26.1years)	201,418 hours (~22.9years)	-
L2 Services - VLANs			
IEEE 802.1Q VLAN Tagging	Yes	802.1Q-1998	Up to 4,093 VLANs - 802.1Q Tagging
Auto-Trunk	Yes	Dynamic VLAN trunking as soon as an M4350 switch gets connected to another M4350 switch, or M4250/M4300 with Auto-Trunk enabled	
Protocol Based VLANs	Yes		
IP subnet	Yes		
ARP	Yes		
IPX	Yes		
Subnet based VLANs	Yes		
MAC based VLANs	Yes		
Voice VLAN	Yes	Based on phones OUI bytes (internal database, or user-maintained) or protocols (SIP, H323 and SCCP)	
Private Edge VLAN	Yes		
Private VLAN	Yes		
IEEE 802.1x	Yes	802.1x-2004	
Guest VLAN	Yes		
RADIUS based VLAN assignment via .1x	Yes	IP phones and PCs can authenticate on the same port but under different VLAN assignment policies	
RADIUS based Filter ID assignment via .1x	Yes		
MAC-based .1x	Yes		
Unauthenticated VLAN	Yes		

Technical Specifications

Double VLAN Tagging	Yes	
Enabling dvlan-tunnel makes interface	Yes	
Global ethertype (TPID)	Yes	
Interface ethertype (TPID)	Yes	
Customer ID using PVID	Yes	
GARP with GVRP/GMRP	Yes	Automatic registration for membership in VLANs or in multicast groups
Multiple Registration Protocol (MRP)	Yes	Can replace GARP functionality
Multicast VLAN Registration Protocol (MVRP)	Yes	Can replace GARP functionality
MVR (Multicast VLAN registration)	Yes	
L2 Services - Availability		
IEEE 802.3ad - LAGs	Yes	Up to 64 LAGs and up to 8 ports per group
LACP	Yes	
LACP automatically reverts to and from Static LAG	Yes	
Static LAGs	Yes	
LAG Hashing	Yes	
LAG Member Port Flaps Tracking	Yes	
Auto-LAG	Yes	If more than one link between two M4250 switches, a Link Aggregation Group is created, dynamically
LAG Local Preference	Yes	Known unicast traffic egresses only out of local blade LAG interface members
Distributed Link Aggregation	Yes	LAGs across the stack
Storm Control	Yes	
IEEE 802.3x (Full Duplex and flow control)	Yes	Asymmetric and Symmetric Flow Control <i>Limitation: Enabling, changing, or disabling flow control on a port, a service interruption is observed on that port during 4 to 6 seconds before the traffic resumes.</i>
Per port Flow Control	Yes	
UDLD Support (Unidirectional Link Detection)	Yes	
Normal-Mode	Yes	
Aggressive-Mode	Yes	
Link Dependency	Yes	Allow the link status of specified ports to be dependent on the link status of other ports
IEEE 802.1D Spanning Tree Protocol	Yes	
IEEE 802.1w Rapid Spanning Tree	Yes	
IEEE 802.1s Multiple Spanning Tree	Yes	
Per VLAN STP (PVSTP) with FastUplink and FastBackbone	Yes	PVST+ interoperability
Per VLAN Rapid STP (PVRSTP)	Yes	RPVST+ interoperability
STP Loop Guard	Yes	
STP Root Guard	Yes	
STP BPDU Guard	Yes	

Technical Specifications

STP BPDU Filtering	Yes	
STP BPDU Flooding	Yes	
L2 Services - Multicast Filtering		
IGMPv2 Snooping Support	Yes	
IGMPv3 Snooping Support	Yes	
NETGEAR IGMP Plus™ Enhanced Implementation	Yes	For automatic multicast across M4250 / M4300 / M4350 / M4500 (Spine and Leaf) at Layer 2, removing the need for L3 PIM routing
MLDv1 Snooping Support	Yes	
MLDv2 Snooping Support	Yes	
Expedited Leave function	Yes	
Static L2 Multicast Filtering	Yes	
Enable IGMP / MLD Snooping per VLAN	Yes	
IGMPv1/v2 Snooping Querier, compatible v3 queries	Yes	
MLDv1 Snooping Querier	Yes	
MGMD Snooping		
Control Packet Flooding	Yes	
Flooding to mRouter Ports	Yes	
Remove Flood-All-Unregistered Option	Yes	
Multicast VLAN registration (MVR)	Yes	
L3 Services - Multicast Routing		
IGMP Proxy	Yes	
MLD Proxy	Yes	
Any Source Multicast (ASM)	Yes	
Source Specific Multicast (SSM)	Yes	
Multicast streams routing between subnets, VLANs	Yes	
Multicast static routes (IPv4, IPv6)	Yes	
Neighbor discovery	Yes	
PIM-DM (Multicast Routing - dense mode)	Yes	
PIM-DM (IPv6)	Yes	
PIM-SM (Multicast Routing - sparse mode)	Yes	
PIM-SM (IPv6)	Yes	
PIM multi-hop RP support	Yes	
PIM Timer Accuracy	Yes	
PIM-SM Unhandled Events	Yes	
IPMC replication (hardware support)	Yes	

Technical Specifications

L3 Services - DHCP	
DHCP IPv4 / DHCP IPv6 Client	Yes
DHCP IPv4 / DHCP IPv6 Server (Stateless, Stateful)	Yes
DHCP Snooping IPv4 / IPv6	Yes
BootP Relay IPv4 / IPv6	Yes
DHCP Relay IPv4 / IPv6	Yes
DHCP Relay Option 82 circuit-id and remote-id for VLANs	Yes
Multiple Helper IPs	Yes
Auto Install (DHCP options 66, 67, 150 and 55, 125)	Yes
L3 Services - Routing	
Static Routing / ECMP Static Routing	IPv4/IPv6
Multiple next hops to a given destination	Yes
Load sharing, Redundancy	Yes
Default routes	Yes
Static Reject routes	Yes
Port Based Routing	Yes
VLAN Routing	Yes
802.3ad (LAG) for router ports	Yes
VRRP	IPv4
Pingable VRRP interface	Yes
VRRP Route/Interface Tracking	Yes
Loopback Interfaces	Yes
Tunnel interfaces	IPv4 / IPv6
Configured 6to4 tunnels	Yes
Automatic 6to4 tunnels	Yes
6to4 Border Router	Yes
RIP	IPv4
RIPv1/RIPv2	Yes
Route Redistribution	Yes Enables the exchange of routing information among different routing protocols operating within a router

Technical Specifications

OSPF	IPv4/IPv6
OSPFv2 RFC 2328 including older RFC 1583 support	Yes
OSPFv3	Yes
OSPF Not-So-Stubby Area (NSSA) Option	Yes
Forwarding of OSPF Opaque LSAs	Yes
Passive interface feature	Yes
Static Area Range Costs feature	Yes
OSPF Equal Cost Multipath (ECMP)	Yes
Dynamically learned ECMP routes	Yes
Statically learned ECMP routes	Yes
OSPF Max Metric feature	Yes
Automatic Exiting of Stub Router Mode feature	Yes
Static Area Range Costs feature	Yes
OSPF LCA Pacing feature	Yes
OSPF Flood Blocking feature	Yes
OSPF Transit-Only Network Hiding	Yes
IP Multinetting	Yes
ICMP throttling	Yes
Router Discovery Protocol	Yes
DNS Client	IPv4/IPv6
IP Helper	Yes
Max IP Helper entries	512
IP Event Dampening	IPv4/IPv6
Proxy ARP	IPv4/IPv6
ICMP	IPv4/IPv6
ICMP redirect detection in hardware	Yes
Policy Based Routing (PBR)	IPv4/IPv6
Based on the size of the packet	Yes
Based on the Protocol of the payload (Protocol ID field)	Yes
Based on Source MAC address	Yes
Based on Source or Destination IP address	Yes
Based on VLAN tag	Yes
Based on Priority(802.1P priority)	Yes

Technical Specifications

Network Monitoring and Discovery Services			
ISDP (Industry Standard Discovery Protocol)	Yes		Can interoperate with devices running CDP
802.1ab LLDP	Yes		
802.1ab LLDP - MED	Yes		
SNMP	V1, V2, V3		
RMON 1,2,3,9	Yes		
sFlow	Yes (IPv4 and IPv6 headers)		
Security			
Network Storm Protection, DoS			
Broadcast, Unicast, Multicast DoS Protection	Yes		
Denial of Service Protection (control plane)	Yes		Switch CPU protection
Denial of Service Protection (data plane)	Yes		Switch Traffic protection
DoS Attacks Protection	SIPDIP SMACDMAC FIRSTFRAG TCPFRAG TCPFLAG TCPPORT	UDPPORT TCPFLAGSEQ TCPOFFSET TCPSYN TCPSYNFIN TCPFINURGPSH	L4PORT ICMP ICMPV4 ICMPV6 ICMPFRAG PINGFLOOD SYNACK
CPU Rate Limiting	Yes	Applied to IPv4 and IPv6 multicast packets with unknown L3 addresses when IP routing/multicast enabled	
ICMP throttling	Yes	Restrict ICMP, PING traffic for ICMP-based DoS attacks	
Management			
Management ACL (MACAL)	Yes	Protects management CPU access through the LAN	
Max Rules	64		
Out of band Management	Yes	In-band management can be shut down entirely when out-of-band management network	
Radius accounting	Yes	RFC 2565 and RFC 2866	
TACACS+	Yes		
Malicious Code Detection	Yes	Software image files and Configuration files with digital signatures	
Network Traffic			
Access Control Lists (ACLs)	L2 / L3 / L4	MAC, IPv4, IPv6, TCP, UDP	
Time-based ACLs	Yes		
Protocol-based ACLs	Yes		
ACL over VLANs	Yes		
Dynamic ACLs	Yes		
IEEE 802.1x Radius Port Access Authentication	Yes	Up to 48 clients (802.1x) per port are supported, including the authentication of the users domain	

Technical Specifications

802.1x MAC Address Authentication Bypass (MAB)	Yes	Supplemental authentication mechanism for non-802.1x devices, based on their MAC address only
Network Authentication Successive Tiering	Yes	Dot1x-> MAP -> Captive Portal successive authentication methods based on configured time-outs
Port Security	Yes	
IP Source Guard	Yes	IPv4 / IPv6
DHCP Snooping	Yes	IPv4 / IPv6
Dynamic ARP Inspection	Yes	IPv4 / IPv6
IPv6 RA Guard Stateless Mode	Yes	
MAC Filtering	Yes	
Port MAC Locking	Yes	
Private Edge VLAN	Yes	A protected port doesn't forward any traffic (unicast, multicast, or broadcast) to any other protected port - same switch
Private VLANs	Yes	Scales Private Edge VLANs by providing Layer 2 isolation between ports across switches in same Layer 2 network
Quality of Service (QoS) - Summary		
Access Lists	Yes	
L2 MAC, L3 IP and L4 Port ACLs	Yes	
Ingress	Yes	
Egress	Yes	
Time-based	Yes	
802.3ad (LAG) for ACL assignment	Yes	
Binding ACLs to VLANs	Yes	
ACL Logging	Yes	
Support for IPv6 fields	Yes	
DiffServ QoS	Yes	
Edge Node applicability	Yes	
Interior Node applicability	Yes	
802.3ad (LAG) for service interface	Yes	
Support for IPv6 fields	Yes	
Ingress/Egress	Yes	
IEEE 802.1p COS	Yes	
802.3ad (LAG) for COS configuration	Yes	
WRED (Weighted Deficit Round Robin)	Yes	
Strict Priority queue technology	Yes	
Single Rate Policing	Yes (CLI only)	
Committed Information Rate	Yes	
Committed Burst Size	Yes	
Excessive Burst Size	Yes	
DiffServ feature applied to class maps	Yes	
Auto-VoIP	Yes	Yes, based on protocols (SIP, H323 and SCCP) or on OUI bytes (default database and user-based OUIs) in the phone source MAC address

Technical Specifications

QoS - ACL Feature Support

ACL Support (general, includes IP ACLs)	Yes
MAC ACL Support	Yes
IP Rule Match Fields:	
Destination IP	Inbound/Outbound
Destination IPv6 IP	Inbound/Outbound
Destination L4 Port	Inbound/Outbound
Every Packet	Inbound/Outbound
IP DSCP	Inbound/Outbound
IP Precedence	Inbound/Outbound
IP TOS	Inbound/Outbound
Protocol	Inbound/Outbound
Source IP (for Mask support see below)	Inbound/Outbound
Source IPv6 IP	Inbound/Outbound
L3 IPv6 Flow Label	Inbound
Source L4 Port	Inbound/Outbound
TCP Flag (ack, est, fin)	Inbound/Outbound
Supports Masking	Inbound/Outbound
MAC Rule Match Fields	
COS	Inbound/Outbound
Destination MAC	Inbound/Outbound
Destination MAC Mask	Inbound/Outbound
Ethertype	Inbound/Outbound
Source MAC	Inbound/Outbound
Source MAC Mask	Inbound/Outbound
VLAN ID	Inbound/Outbound
Rules attributes	
Assign Queue	Inbound
Logging -- deny rules	Inbound/Outbound
Mirror (to supported interface types only)	Inbound
Redirect (to supported interface types only)	Inbound
Rate Limiting -- permit rules	Inbound/Outbound
Interface	
Inbound direction	Yes
Outbound direction	Yes
Supports LAG interfaces	Yes
Supports Control-plane interface	Yes
Multiple ACLs per interface, dir	Yes
Mixed-type ACLs per interface, dir	Yes
Mixed L2/IPV4 ACLs per interface, inbound	Yes
Mixed IPv4/IPV6 ACLs per interface, inbound	Yes
Mixed IPv4/IPV6 ACLs per interface, outbound	Yes

Technical Specifications

QoS - DiffServ Feature Support

DiffServ Supported	Yes
Class Type	
All	Yes
Class Match Criteria	
COS	Inbound/Outbound
COS2 (Secondary COS)	Inbound
Destination IP (for Mask support see below)	Inbound/Outbound
Destination IPv6 IP	Inbound/Outbound
Destination L4 Port	Inbound/Outbound
Destination MAC (for Mask support see below)	Inbound/Outbound
Ethertype	Inbound/Outbound
Every Packet	Inbound/Outbound
IP DSCP	Inbound/Outbound
IP Precedence	Inbound/Outbound
IP TOS (for Mask support see below)	Inbound/Outbound
Protocol	Inbound/Outbound
Reference Class	Inbound/Outbound
Source IP (for Mask support see below)	Inbound/Outbound
Source IPv6 IP	Inbound/Outbound
L3 IPv6 Flow Label	Inbound
Source L4 Port	Inbound/Outbound
Source MAC (for Mask support see below)	Inbound/Outbound
VLAN ID (Source VID)	Inbound/Outbound
VLAN ID2 (Secondary VLAN) (Source VID)	Inbound/Outbound
Supports Masking	Inbound/Outbound
Policy	
Out Class Unrestricted	Yes
Policy Attributes -- Inbound	
Assign Queue	Yes
Drop	Yes
Mark COS	Yes
Mark COS-AS-COS2	Yes
Mark COS2 (Secondary COS)	Yes
Mark IP DSCP	Yes
Mark IP Precedence	Yes
Mirror (to supported interface types only)	Yes
Police Simple	Yes
Police Single-Rate	Yes
Police Two-Rate	Yes
Police Color Aware Mode	Yes
Redirect (to supported interface types only)	Yes

Technical Specifications

Policy Attributes -- Outbound	Yes
Drop	Yes
Mark COS	Yes
Mark IP DSCP	Yes
Mark IP Precedence	Yes
Mirror (to supported interface types only)	Yes
Police Simple	Yes
Police Single-Rate	Yes
Police Two-Rate	Yes
Police Color Aware Mode	Yes
Redirect (to supported interface types only)	Yes
Service Interface	
Inbound Slot.Port configurable	Yes
Inbound 'All' Ports configurable	Yes
Outbound Slot.Port configurable	Yes
Outbound 'All' Ports configurable	Yes
Supports LAG interfaces	Yes
Mixed L2/IPv4 match criteria, inbound	Yes
Mixed IPv4/IPv6 match criteria, inbound	Yes
Mixed IPv4/IPv6 match criteria, outbound	Yes
PHB Support	
EF	Yes
AF4x	Yes
AF3x	Yes
AF2x	Yes
AF1x	Yes
CS	Yes
Statistics -- Policy Instance	
Offered	packets
Discarded	packets
QoS - COS Feature Support	
COS Support	Yes
Supports LAG interfaces	Yes
COS Mapping Config	
Configurable per-interface	Yes
IP DSCP Mapping	Yes
COS Queue Config	
Queue Parms configurable per-interface	Yes
Drop Parms configurable per-interface	Yes
Interface Traffic Shaping (for whole egress interface)	Yes
Minimum Bandwidth	Yes
Weighted Deficit Round Robin (WDRR) Support	Yes
Maximum Queue Weight	127
WRED Support	Yes

Technical Specifications

TSN - Time Sensitive Networking AVB Feature Support

AVB	
IEEE 802.1BA-2011 Audio Video Bridging (AVB)	Yes (no license)
IEEE 802.1AS-2011 gPTP	Yes
IEEE 802.1Qav-2009 FQTS	Yes
IEEE 802.1Qat-2010 MSRP	Yes
IEEE 802.1ak MMRP	Yes
IEEE 802.1ak MVRP	Yes
Max number of AVB streams	500 streams per switch
Limitations	AVB isn't supported on a LAG (link aggregation group, or port channel) Standalone mode only (Stacking and AVB are mutually exclusive features).

PTP - PTPv2 Feature Support

PTPv2	
IEEE 1588 PTPv2	Yes
Implementation	Transparent Clock (TC) End-to-End implementation considering the residence time of PTPv2 packets from ingress to egress
Limitations	Standalone mode only (Stacking and PTPv2 TC are mutually exclusive features). PTPv1 packets are forwarded but not processed (no PTPv1 support).
Method	Residence time of the PTPv2 packet at the egress port level
PTPv2 packet fields that are updated	The "Sync & Delay_Req" field of passing/egressing out PTPv2 packets is updated with the residence time in the switch
PTPv2 packet fields that are NOT updated	Other fields in PTPv2 packets ("Announce", "Delay_Resp", "Pdelay_Req" and "Pdelay_Resp") are not updated

PTP - SMPTE ST 2110 Support M4350-16V4C (VSM4320C) and M4350-40X4C (XSM4344C) only

PTPv2	
IEEE 1588 PTPv2 Section 10 and 11.5	Yes
Implementation	SMPTE ST 2110 is supported on M4350-16V4C (VSM4320C) and M4350-40X4C (XSM4344C) only Boundary Clock mode (BC) Grandmaster Clock mode (GM)
Single-Step / Two-Step	Single-step PTP or two-step PTP to the GrandMaster and AV endpoints
PTP Profiles	Only one PTP profile supported at a time on one switch, amongst: SMPTE 2059-2 PTP profile (video/audio) AES67 PTP profile (audio) AES-R16-2016 proposing interoperability between the first profiles (interoperability between IEE1588v2, AES67 and SMPTE 2059-2)
Operation Modes	On M4350, PTP operates in multicast (all messages between the grandmaster and slaves use multicast)
Time Precision	Time accuracy of the client compared to the master: +/- 500 nanoseconds of cumulated offset between the grand master and the endpoint

Technical Specifications

Functional Summary - IETF RFC Standards and IEEE Network Protocols

Core Management	
RFC 854 – Telnet	RFC 3414 – User-Based Security Model
RFC 855 – Telnet option specifications	RFC 3415 – View-based Access Control Model
RFC 1155 – SMI v1	RFC 3416 – Version 2 of SNMP Protocol Operations
RFC 1157 – SNMP	RFC 3417 – Transport Mappings
RFC 1212 – Concise MIB definitions	RFC 3418 – Management Information Base (MIB) for the Simple Network Management Protocol (SNMP)
RFC 1867 – HTML/2.0 forms with file upload extensions	Configurable Management VLAN
RFC 1901 – Community-based SNMP v2	SSL 3.0 and TLS 1.2
RFC 1908 – Coexistence between SNMP v1 and SNMP v2	- RFC 2246 – The TLS protocol, version 1.0
RFC 2068 – HTTP/1.1 protocol as updated by draft-ietf-http-v11-spec-rev-03	- RFC 2346 – AES cipher suites for Transport layer security
RFC 2271 – SNMP framework MIB	- RFC 2818 – HTTP over TLS SSH 2.0
RFC 2295 – Transparent content negotiation	SSH 2.0
RFC 2296 – Remote variant selection; RSVP/1.0 state management cookies – draft-ietf-http-state-mgmt-05	- RFC 4253 – SSH transport layer protocol
RFC 2576 – Coexistence between SNMP v1, v2, and v3	- RFC 4252 – SSH authentication protocol
RFC 2578 – SMI v2	- RFC 4254 – SSH connection protocol
RFC 2579 – Textual conventions for SMI v2	- RFC 4251 – SSH protocol architecture
RFC 2580 – Conformance statements for SMI v2	- RFC 4716 – SECSH public key file format
RFC 3410 – Introduction and Applicability Statements for Internet Standard Management Framework	- RFC 4419 – Diffie-Hellman group exchange for the SSH transport layer protocol
RFC 3411 – An Architecture for Describing SNMP Management Frameworks	HTML 4.0 specification, December 1997
RFC 3412 – Message Processing & Dispatching	
RFC 3413 – SNMP Applications	Java Script™ 1.3

Advanced Management

Industry-standard CLI with the following features:	
- Scripting capability	Optional user password encryption
- Command completion	Multisession Telnet server
- Context-sensitive help	Auto Image Upgrade

Technical Specifications

Core Switching	
IEEE 802.1AB – Link level discovery protocol	IEEE 802.1BA-2011, 802.1AS-2011 gPTP, 802.1Qav-2009 FQTS, 802.1Qat-2010 MSRP, 802.1ak MMRP, MVRP with AVB license
IEEE 802.1D – Spanning tree	IEEE 802.3ac – VLAN tagging
IEEE 802.1p – Ethernet priority with user provisioning and mapping	IEEE 802.3ad – Link aggregation
IEEE 802.1Q – Virtual LANs w/ port-based VLANs	IEEE 802.3ae – 10 GbE
IEEE 802.1S – Multiple spanning tree compatibility	IEEE 802.3af – Power over Ethernet
IEEE 802.1v – Protocol-based VLANs	IEEE 802.3at – Power over Ethernet Plus
IEEE 802.1W – Rapid spanning tree	IEEE 802.3x – Flow control
IEEE 802.1AB – LLDP	ANSI/TIA-1057 – LLDP-MED
IEEE 802.1X – Port-based authentication	GARP – Generic Attribute Registration Protocol: clause 12, 802.1D-2004
IEEE 802.3 – 10Base-T	GMRP – Dynamic L2 multicast registration: clause 10, 802.1D-2004
IEEE 802.3u – 100Base-T	GVRP – Dynamic VLAN registration: clause 11.2, 802.1Q-2003
IEEE 802.3ab – 1000Base-T	RFC 4541 – IGMP snooping and MLD snooping
IEEE 802.3bz-2016 – 2.5GBASE-T	RFC 5171 – UniDirectional Link Detection (UDLD) Protocol
Additional Layer 2 Functionality	
Broadcast storm recovery	IGMP and MLD snooping querier
Double VLAN/VLAN tagging	Port MAC locking
DHCP Snooping	MAC-based VLANs
Dynamic ARP inspection	IP source guard
Independent VLAN Learning (IVL) support	IP subnet-based VLANs
IPv6 classification APIs	Voice VLANs
Jumbo Ethernet frames	Protected ports
Port mirroring	IGMP snooping
Static MAC filtering	Green Ethernet power savings mode

Technical Specifications

System Facilities	
Event and error logging facility	RFC 2030 – Simple Network Time Protocol (SNTP) V4 for IPv4, IPv6, and OSI
Runtime and configuration download capability	RFC 2131 – DHCP Client/Server
PING utility	RFC 2132 – DHCP options and BOOTP vendor extensions
XMODEM	RFC 2865 – RADIUS client
RFC 768 – UDP	RFC 2866 – RADIUS accounting
RFC 783 – TFTP	RFC 2868 – RADIUS attributes for tunnel protocol support
RFC 791 – IP	RFC 2869 – RADIUS extensions
RFC 792 – ICMP	RFC 28869bis – RADIUS support for Extensible Authentication Protocol (EAP)
RFC 793 – TCP	RFC 5176 – RADIUS Change of Auth
RFC 826 – ARP	RFC 3164 – The BSD syslog protocol with RFC 5424 update
RFC 951 – BOOTP	RFC 3580 – 802.1X RADIUS usage guidelines
RFC 1321 – Message digest algorithm	Power Source Equipment (PSE) IEEE 802.af Powered Ethernet (DTE Power via MDI) standard
RFC 1534 – Interoperability between BOOTP and DHCP	
Core Routing	
RFC 826 – Ethernet ARP	RFC 1812 – Requirements for IPv4 routers
RFC 894 – Transmission of IP datagrams over Ethernet networks	RFC 2082 – RIP-2 MD5 authentication
RFC 896 – Congestion control in IP/TCP networks	RFC 2131 – DHCP relay
RFC 1027 – Using ARP to implement transparent subnet gateways (Proxy ARP)	RFC 2385 – Protection of BGP Sessions via the TCP MD5 Signature Option
RFC 1256 – ICMP router discovery messages	RFC 2453 – RIP v2
RFC 1321 – Message digest algorithm	RFC 3021 – Using 31-Bit Prefixes on Point-to-Point Links
RFC 1519 – CIDR	RFC 3046 – DHCP/BOOTP relay
Quality of Service - DiffServ	
RFC 2474 – Definition of the differentiated services field (DS Field) in IPv4/IPv6 headers	RFC 2697 – A Single Rate Three Color Marker
RFC 2475 – An architecture for differentiated services	RFC 3246 – An expedited forwarding PHB (Per-Hop Behavior)
RFC 2597 – Assured forwarding PHB group	RFC 3260 – New terminology and clarifications for DiffServ

Technical Specifications

Quality of Service - Access Control Lists (ACLs)

<p>Permit/deny actions for inbound or outbound IP traffic classification based on:</p> <ul style="list-style-type: none"> - Type of service (ToS) or differentiated services (DS) DSCP field - Source IP address - Destination IP address - TCP/UDP source port - TCP/UDP destination port - IPv6 flow label - IP protocol number 	<p>Permit/deny actions for inbound or outbound Layer 2 traffic classification based on:</p> <ul style="list-style-type: none"> - Source MAC address - Destination MAC address - EtherType - VLAN identifier value or range (outer and/or inner VLAN tag) - 802.1p user priority (outer and/or inner VLAN tag) <p>Optional rule attributes:</p> <ul style="list-style-type: none"> - Assign matching traffic flow to a specific queue - Redirect or mirror (flow-based mirroring) matching traffic flow to a specific port 	<ul style="list-style-type: none"> - Generate trap log entries containing rule hit counts
--------------------------------------------------------------------------------------------------------------------------------------------------------------------------------------------------------------------------------------------------------------------------------------------------------------------------------------------------------------------------------------------------------	------------------------------------------------------------------------------------------------------------------------------------------------------------------------------------------------------------------------------------------------------------------------------------------------------------------------------------------------------------------------------------------------------------------------------------------------------------------------------------------------------------------------------------------------------------------------------------------------------	----------------------------------------------------------------------------------------------------------

Quality of Service - Class of Service (CoS)

<p>Direct user configuration of the following:</p> <ul style="list-style-type: none"> - IP DSCP to traffic class mapping - IP precedence to traffic class mapping - Interface trust mode: 802.1p, IP Precedence, IP DSCP, or untrusted - Interface traffic shaping rate - Minimum and maximum bandwidth per queue - Strict priority versus weighted (WRR/WDRR/WFQ) scheduling per queue - Tail drop versus Weighted Random Early Detection (WRED) queue depth management 	<p>Auto VoIP</p>
-----------------------------------------------------------------------------------------------------------------------------------------------------------------------------------------------------------------------------------------------------------------------------------------------------------------------------------------------------------------------------------------------------------------------------------------------------------------------------------------------------------------------------------------------	------------------

Core Multicast

<p>RFC 1112 – Host extensions for IP multicasting</p>	<p>RFC3973 – PIM-DM</p>
<p>RFC 2236 – IGMP v2</p>	<p>RFC4601 – PIM-SM</p>
<p>RFC 2710 – MLDv1</p>	<p>Draft-ietf-magma-igmp-proxy-06.txt – IGMP/MLD-based multicast forwarding (IGMP/MLD proxying)</p>
<p>RFC 2365 – Administratively scoped boundaries</p>	<p>Draft-ietf-magma-igmpv3-and-routing-05.txt – IGMPv3 and multicast routing protocol interaction</p>
<p>RFC 3376 – IGMPv3</p>	<p>Static RP configuration</p>
<p>RFC3810 – MLDv2</p>	<p>Static RP configuration</p>

Core IPv6 Routing

<p>RFC 1981 – Path MTU for IPv6</p>	<p>RFC 3493 – Basic socket interface for IPv6</p>
<p>RFC 2373 – IPv6 addressing</p>	<p>RFC 3513 – Addressing architecture for IPv6</p>
<p>RFC 2460 – IPv6 protocol specification</p>	<p>RFC 3542 – Advanced sockets API for IPv6</p>
<p>RFC 2461 – Neighbor discovery</p>	<p>RFC 3587 – IPv6 global unicast address format</p>

Technical Specifications

RFC 2462 – Stateless autoconfiguration	RFC 3736 – Stateless DHCPv6
RFC 2464 – IPv6 over Ethernet	RFC 4213 – Basic transition mechanisms for IPv6
RFC 2711 – IPv6 router alert	RFC 4291 – Addressing architecture for IPv6
RFC 3056 – Connection of IPv6 Domains via IPv4 Clouds	RFC 4443 – Internet Control Message Protocol (ICMPv6) for the IPv6 Specification
RFC 3315 – Dynamic Host Configuration Protocol for IPv6 (DHCPv6)	RFC 6164 – Using 127-Bit IPv6 Prefixes on Inter-Router Links
RFC 3484 – Default address selection for IPv6	RFC 6583 – Operational Neighbor Discovery Problems
RFC 3493 – Basic socket interface for IPv6	RFC 6583 – Operational Neighbor Discovery Problems

Supported MIBs

Base Package MIBs

ANSI/TIA-1057 – LLDP-EXT-MED-MIB	RFC 2674 – Q-BRIDGE-MIB
DIFFSERV DSCP TC (Draft – no RFC)	RFC 2677 – IANA Address Family Numbers MIB
DNS-RESOLVER-MIB (IETF DNS Working Group)	RFC 2819 – RMON MIB
DNS-SERVER-MIB (IETF DNS Working Group)	RFC 2925 – DISMAN-PING-MIB and DISMAN-TRACEROUTE-MIB
GreenEthernet Private MIB	RFC 3273 – RMON MIB for High Capacity Networks
IANA-ADDRESS-FAMILY-NUMBERS-MIB (IANA (3/2002)	RFC 3411 – SNMP Management Frameworks MIB
IEEE 802.1AB-2004 – LLDP MIB	RFC 3411 – SNMP-FRAMEWORK-MIB
IEEE 802.1AB-2005 – LLDP-EXT-DOT3-MIB	RFC 3412 – SNMP-MPD-MIB
POWER ETHERNET MIB (Draft – no RFC)	RFC 3413 – SNMP-NOTIFICATION-MIB
RFC 1155 – SMI-MIB	RFC 3413 – SNMP-PROXY-MIB (initial revision published as RFC 2273)
RFC 1450 – SNMPV2-MIB	RFC 3413 – SNMP-TARGET-MIB (initial revision published as RFC 2273)
RFC 2273 – SNMP Notification MIB, SNMP Target MIB	RFC 3414 – User-based Security Model for SNMPv3 MIB
RFC 2392 – IANA RTPROTO-MIB	RFC 3415 – View-based Access Control Model for SNMP MIB
RFC 2572 – SNMP Message Processing and Dispatching MIB	RFC 3417 – SNMPV2-TM
RFC 2574 – User-based Security Model for SNMPv3 MIB	RFC 3418 – SNMPv2 MIB
RFC 2575 – View-based Access Control Model for SNMP MIB	RFC 3434 – RMON MIB Extensions for High Capacity Alarms
RFC 2576 – SNMP Community MIB	RFC 3584 – SNMP Community MIB

Technical Specifications

RFC 2578 – SNMPV2-SMI	RFC 3621 – POWER-ETHERNET-MIB
RFC 2579 – SNMPV2-TC	SNMP-RESEARCH-MIB– SNMP research MIB definitions
RFC 2580– SNMPV2-CONF	SR-AGENT-INFO-MIB– SNMP research MIB definitions
RFC 2613 – SMON-MIB	USM-TARGET-TAG-MIB – SNMP research MIB definitions
Switching Package MIBs	
RFC 1213 – MIB-II	RFC 2011 – SNMPv2 Management Information Base
ANSI/TIA 1057 – LLDP-MED MIB	RFC 2213 – Integrated Services MIB
FASTPATH Enterprise MIBs supporting switching features	RFC 2233 – IF-MIB
FASTPATH-MMRP-MIB – MMRP private MIB for IEEE 802.1Q devices	RFC 2233 – The Interfaces Group MIB using SMI v2
FASTPATH-MSRP-MIB – MSRP private MIB for IEEE 802.1Q devices	RFC 2674 – VLAN and Ethernet Priority MIB (P-Bridge MIB)
FASTPATH-MVRP-MIB – MVRP private MIB for IEEE 802.1Q devices	RFC 2737 – Entity MIB (Version 2)
IANAifType-MIB – IANAifType Textual Convention	RFC 2819 – RMON Groups 1,2,3, & 9
IEEE 802.1AB – LLDP MIB	RFC 2863 – Interfaces Group MIB
IEEE 802.3AD MIB (IEEE8021-AD-MIB)	RFC 3291 – INET Address MIB
IEEE Draft P802.1AS/D7.0 (IEEE8021-AS-MIB)	RFC 3291 – Textual Conventions for Internet Network Addresses
IEEE LAG-MIB – Link Aggregation module for managing IEEE 802.3ad	RFC 3621 – Power Ethernet MIB
LLDP-EXT-DOT3-MIB (part of IEEE Std 802.1AB)	RFC 3635 – Etherlike MIB
LLDP-MIB (part of IEEE Std 802.1AB)	RFC 3636 – IEEE 802.3 Medium Attachment Units (MAUs) MIB
Private MIB for 802.1Qat, 802.1Qav Configuration	RFC 4022 – Management Information Base for the Transmission Control Protocol (TCP)
RFC 1493 – Bridge MIB	RFC 4113 – Management Information Base for the User Datagram Protocol (UDP)
RFC 1643 – Definitions of managed objects for the Ethernet-like interface types	RFC 4444 – IS-IS MIB
Routing Package MIBs	
FASTPATH Enterprise MIBs supporting routing features	RFC 2096 – IP Forwarding Table MIB
IANA-Address-Family-Numbers-MIB	RFC 2668 – IEEE 802.3 Medium Attachment Units (MAUs) MIB

Technical Specifications

IPv6 Management MIBs		
RFC 3419 – TRANSPORT-ADDRESS-MIB		IPv6-MIB (draft)
IPv6-ICMP-MIB (draft)		
IPv6 Routing MIBs		
RFC 2465 – IPv6 MIB		RFC 2466 – ICMPv6 MIB
QoS Package MIB		
RFC 3289 – DIFFSERV-MIB & DIFFSERV-DCSP-TC MIBs		Private MIBs for full configuration of DiffServ, ACL, and CoS functionality
Security MIB		
RFC 2618 – RADIUS Authentication Client MIB		IEEE8021-PAE-MIB – The Port Access Entity module for managing IEEE 802.1X
RFC 2620 – RADIUS Accounting MIB		IEEE 802.1X MIB (IEEE 8021-PAE-MIB 2004 Revision)
Multicast Package MIBs		
RFC 2932 – IPv4 Multicast Routing MIB for PIMDMv4		draft-ietf-magma-mgmd-mib-05.txt –Multicast Group Membership Discovery MIB (both IGMP and MLD)
RFC 5060 – PIM-SM and PIM-DM MIB for IPv4 and IPv6		FASTPATH Enterprise MIBs supporting multicast features
RFC 5240 – BSR Protocol MIB		
Management		
Password management	Yes	
Configurable Management VLAN	Yes	
Out-of-band Management	Yes	In-band management can be shut down using Management ACLs when separate management network
Auto Install (BOOTP and DHCP options 66, 67, 150 and 55, 125)	Yes	Scalable deployment process (firmware, config)
Admin access control via Radius and TACACS+	Yes	Policies, Enable
Industry standard CLI (IS-CLI)	Yes	Command Line interface
CLI commands logged to a Syslog server	Yes	

Technical Specifications

Web-based graphical user interface (GUI)	Yes	Fully functional GUI (exceptions are noted below:)
Features without Web GUI support		
Authorization List	CLI only	
Control Plane ACL	CLI only	
UDLD	CLI only	
Policy Based Routing	CLI only	
LLPF	CLI only	
QoS Policy for Single Rate	CLI only	
DHCPv6 Snooping	CLI only	
IPv6 DHCP Relay	CLI only	
eMail Alerting	CLI only	
MMRP	CLI only	
Telnet	Yes	
IPv6 management	Yes	
Dual Software (firmware) image	Yes	Allows non disruptive firmware upgrade process
Editable Configuration file	Yes	Text-based (CLI commands) configuration file
Non disruptive Config Management	Yes	With new startup configuration file, the switch gracefully resolves any differences with the running config
IS-CLI Scripting	Yes	
Port descriptions	Yes	
SNTP client over UDP port 123	Yes	Provides synchronized network timestamp either in broadcast or unicast mode
XMODEM	Yes	
SNMP v1/v2	Yes	
SNMP v3 with multiple IP addresses	Yes	
RMON 1,2,3,9	Yes	
Max Ether Stats entries	3 * (number of ports in the stack + LAG + 10)	
Max History entries	10	
Max buckets per History entry	3 * (number of ports in the stack + LAG + 10)	
Max Alarm entries	3 * (number of ports in the stack + LAG + 10)	
Max Event entries	10	
Max Log entries per Event entry		
Port Mirroring	Yes	
Number of monitor sessions	1 (multiple sessions are configurable)	
Tx/Rx	Yes	
Many to One Port Mirroring	Yes	
LAG supported as source ports	Yes	
Max source ports in a session	Total switch port count	

Technical Specifications

Remote Port Mirroring (RSPAN)	Yes	When a particular session is enabled, any traffic entering or leaving the source ports of that session is copied (mirrored) onto a Remote Switched Port Analyzer (RSPAN) VLAN
Flow based mirroring	Yes	
Cable Test utility	Yes	CLI, Web GUI
Outbound Telnet	Yes	
SSHv2	Yes	Secure Shell version 2 (OpenSSH 7.5p1)
SSH Session Configuration	Yes	
SSL v3 and TLS v1.2 for HTTPS web-based access	Yes	Open SSL 1.0.2o
2048-bit RSA key pairs	Yes	For SSLv3 and SSHv2
SHA2-256 and SHA2-512 cryptographic hash functions	Yes	For SSLv3 and SSHv2
File transfers (uploads, downloads)	TFTP / HTTP	
Secured protocols for file transfers	SCP / SFTP / HTTPS	
HTTP Max Sessions	16	
SSL/HTTPS Max Sessions	16	
HTTP Download (firmware)	Yes	
Email Alerting	Yes (CLI only)	
Syslog (RFC 3164) (RFC 5424)	Yes, forwarding messages via UDP using the Syslog protocol to one or more collectors or relays	
Persistent log supported	Yes	
User Admin Management		
User ID configuration	Yes	
Max number of configured users	6	
Support multiple READWRITE Users	Yes	
Max number of IAS users (internal user database)	100	
Authentication login lists	Yes	
Authentication Enable lists	Yes	
Authentication HTTP lists	Yes	
Authentication HTTPS lists	Yes	
Authentication Dot1x lists	Yes	
Accounting Exec lists	Yes	

Technical Specifications

Accounting Commands lists	Yes	
Login History	50	
M4350 series - Platform Constants		
Maximum number of remote Telnet connections	5	
Maximum number of remote SSH connections	5	
Number of MAC Addresses	16K	
Number of VLANs	4,093 VLANs (802.1Q) simultaneously	
VLAN ID Range	1 - 4093	
Number of 802.1p Traffic Classes	8 classes (standalone)	7 classes (stack)
IEEE 802.1x Number of .1x clients per port	48	
Number of LAGs	64 LAGs with up to 8 ports per group	
Maximum multiple spanning tree instances (MSTP)	32	
Maximum per VLAN spanning tree instances (PVST)	32	
MAC based VLANs Number supported	Yes 256	
Number of network buffers	246	
Number of log messages buffered	200	
Static filter entries		
Unicast MAC and source port	20	
Multicast MAC and source port	20	
Multicast MAC and destination port (only)	2048	
Subnet based VLANs Number supported	Yes 128	
Protocol Based VLANs	Yes	
Max number of groups	128	
Max protocols	16	
Maximum Multicast MAC Addresses entries	1K	
Jumbo Frame Support Max Size Supported	Yes 12k	
Number of IP Source Guard stations	379	

Technical Specifications

Number of DHCP snooping bindings	32K	
Number of DHCPv6 snooping bindings	32K	
Number of DHCP snooping static entries	1024	
LLDP-MED number of remote nodes	2 x Total stack port count	
LLDP Remote Management address buffers	2 x Total stack port count	
LLDP Unknown TLV address buffers	100	
LLDP Organisationally Defined Large TLV buffers	Total stack port count	
LLDP Organisationally Defined Small TLV buffers	12 x Total stack port count	
Port MAC Locking	Yes	
Dynamic addresses per port	600	
Static addresses per port	20	
sFlow		
Number of samplers	Total stack port count	
Number of pollers	Total stack port count	
Number of receivers	8	
Radius		
Max Authentication servers	32	
Max Accounting servers	32	
Number of Routes (v4/v6)		SDM (System Data Management, or switch database) templates allow for granular system resources distribution depending on IPv4 or IPv6 applications
IPv4 - Default	894 IPv4 Unicast Routes in IPv4 Basic Default SDM Template	
IPv6 - Default	126 IPv6 Unicast Routes in IPv4 Basic Default SDM Template	
IPv4 - Other Template	10K IPv4 Unicast Routes in IPv4 Basic Plus SDM Template	
IPv6 - Other Template	2K IPv6 Unicast Routes in IPv4 Basic Plus SDM Template	
Number of routing interfaces (including port/vlan)	128	
Number of static routes		
IPv4	256	
IPv6	64	
RIP application route scaling		
IPv4	512	
OSPF application route scaling		
IPv4	1,024	
IPv6	256	
OSPF		
OSPFv2 max neighbors	400	
OSPFv3 max neighbors	400	
OSPFv3 max neighbors per interface	100	

Technical Specifications

Tunnels			
Number of configured v6-over-v4 tunnels	8		
Number of automatic (6to4) tunnels	1		
Number of 6to4 next hops	16		
DHCP Server			
Max number of pools	256		
Total max leases	2K		
DNS Client			
Concurrent requests	16		
Name server entries	8		
Seach list entries	6		
Static host entries	64		
Cache entries	128		
Domain search list entries	32		
DHCPv6 Server			
Max number of pools	16		
DNS domain names within a pool	5		
DNS server addresses within a pool	8		
Delegated prefix definitions within a pool	10		
Number of Host Entries (ARP/NDP)			
IPv4 Basic Default SDM Template	4K ARP	512 NDP	
IPv4 Basic Plus SDM Template	12K ARP	2K NDP	SDM (System Data Management, or switch database)
Static v4 ARP Entries	128		
Number of ECMP Next Hops per Route			
	16		
Number of ECMP groups			
	128		
Total ECMP nexthops in Hardware			
	2,048		
Maximum MFDB entries			
	1K		
IGMPv3 / MLDv2 Snooping Limits			
IGMPv3/MLDv2 HW entries when IP Multicast present	128/64		
IP Multicast			
Number of IPv4/IPv6 Multicast Forwarding Entries	1,536 (IPv4) and 512 (IPv6)		
IGMP Group Memberships per system	2K (IPv4) and 2K (IPv6)		
DVMRP Neighbors	256		
PIM-DM Neighbors	256		
PIM-SM Neighbors	256		
PIM-SM Static RP Entries	5		
PIM-SM Candidate RP Group Range Entries	20		
PIM-SM SSM Range Entries	5		
IGMP Sources processed per group per message	64		

Technical Specifications

ACL Limits			
Maximum Number of ACLs (any type)		100	
Maximum Number Configurable Rules per List		1,023 ingress / 511 ingress	
Maximum ACL Rules per Interface and Direction (IPv4)		1,023 ingress / 511 ingress	
Maximum ACL Rules per Interface and Direction (IPv6)		893 ingress / 253 egress	
Maximum ACL Rules (system-wide)		16K	
Maximum ACL Logging Rules (system-wide)		128	
COS Device Characteristics			
Configurable Queues per Port		8 queues (standalone) 7 queues (stack)	
Configurable Drop Precedence Levels		3	
DiffServ Device Limits			
Number of Queues		8 queues (standalone) 7 queues (stack)	
Requires TLV to contain all policy instances combined		Yes	
Max Rules per Class		13	
Max Instances per Policy		28	
Max Attributes per Instance		3	
Max Service Interfaces		116	
Max Table Entries			
Class Table		32	
Class Rule Table		192	
Policy Table		64	
Policy Instance Table		768	
Policy Attribute Table		2304	
Max Nested Class Chain Rule Count		26	
AutoVoIP number of voice calls		48	
LEDs			
Per port	Speed, Link, Activity		If applicable: PoE
Per device (half-width models)	Power, Fan, Stack Master, Stack ID		
Per device (full width models)	Power, Fan, Stack Master, Stack ID		If applicable: Max PoE
Physical Specifications			

Technical Specifications

Dimensions	
M4350-24G4XF	Width: 17.32 inches (440 cm); Height: 1U - 1.7 inches (43.2 cm); Depth: 15.75 inches (400 mm)
M4350-48G4XF	Width: 17.32 inches (440 cm); Height: 1U - 1.7 inches (43.2 cm); Depth: 15.75 inches (400 mm)
M4350-44M4X4V	Width: 17.32 inches (440 cm); Height: 1U - 1.7 inches (43.2 cm); Depth: 15.75 inches (400 mm)
M4350-8X8F	Width: 8.66 inches (220 cm) (half-width); Height: 1U - 1.7 inches (43.2 cm); Depth: 15.75 inches (400 mm)
M4350-12X12F	Width: 8.66 inches (220 cm) (half-width); Height: 1U - 1.7 inches (43.2 cm); Depth: 15.75 inches (400 mm)
M4350-24X4V	Width: 17.32 inches (440 cm); Height: 1U - 1.7 inches (43.2 cm); Depth: 15.75 inches (400 mm)
M4350-24F4V	Width: 17.32 inches (440 cm); Height: 1U - 1.7 inches (43.2 cm); Depth: 15.75 inches (400 mm)
M4350-36X4V	Width: 17.32 inches (440 cm); Height: 1U - 1.7 inches (43.2 cm); Depth: 15.75 inches (400 mm)
M4350-24X8F8V	Width: 17.32 inches (440 cm); Height: 1U - 1.7 inches (43.2 cm); Depth: 15.75 inches (400 mm)
M4350-32F8V	Width: 17.32 inches (440 cm); Height: 1U - 1.7 inches (43.2 cm); Depth: 15.75 inches (400 mm)
M4350-16V4C	Width: 17.32 inches (440 cm); Height: 1U - 1.7 inches (43.2 cm); Depth: 15.75 inches (400 mm)
M4350-40X4C	Width: 17.32 inches (440 cm); Height: 1U - 1.7 inches (43.2 cm); Depth: 15.75 inches (400 mm)

Weight	
M4350-24G4XF	14.13 lb (6.41 kg)
M4350-48G4XF	15.85 lb (7.19 kg)
M4350-44M4X4V	16.18 lb (7.34 kg)
M4350-8X8F	8.93 lb (4.05 kg)
M4350-12X12F	9.48 lb (4.3 kg)
M4350-24X4V	14.51 lb (6.58 kg)
M4350-24F4V	13.78 lb (6.25 kg)
M4350-36X4V	16.16 lb (7.33kg)
M4350-24X8F8V	15.96 lb (7.24 kg)
M4350-32F8V	15.32 lb (6.95kg)
M4350-16V4C	15.77 lb (7.15kg)
M4350-40X4C	17.11 lb (7.76kg)

Technical Specifications

Power Consumption	Switch idle standby, without any port connection	All ports connected full mesh traffic, without PoE	All ports connected full mesh, full PoE, internal PSU	All ports connected full mesh, max PoE budget, modular PSUs
M4350-24G4XF	32W - 109.19 BTU/hr	80W - 272.97 BTU/hr	792.1W - 2702.76 BTU/hr	871.2W - 2972.73BTU/hr
M4350-48G4XF	48.5W - 165.49 BTU/hr	99W - 337.8 BTU/hr	348W - 1187.43 BTU/hr	1618.3W - 5521.94BTU/hr
M4350-44M4X4V	56.5W - 192.79 BTU/hr	133.5W - 455.52 BTU/hr	351.5W - 1199.37 BTU/hr	3857.5W - 13162.27BTU/hr
M4350-8X8F	30.5W - 104.07 BTU/hr	81.1W - 276.72 BTU/hr	-	-
M4350-12X12F	34W - 116.01 BTU/hr	95.8W - 326.88 BTU/hr	-	-
M4350-24X4V	53.6W - 182.89 BTU/hr	119.4W - 407.41 BTU/hr	750.1W - 2559.45 BTU/hr	907.8W - 3097.46BTU/hr
M4350-24F4V	45.2W - 154.23 BTU/hr	119.3W - 407.07 BTU/hr	-	-
M4350-36X4V	59.3W - 202.34 BTU/hr	148W - 505 BTU/hr	454W - 1549.11 BTU/hr	2071.4W - 7068.01BTU/hr
M4350-24X8F8V	53.4W - 182.21 BTU/hr	151.8W - 517.96 BTU/hr	464W - 1583.23 BTU/hr	2057.3W - 7019.79BTU/hr
M4350-32F8V	42.6W - 145.36 BTU/hr	156.4W - 533.66 BTU/hr	-	-
M4350-16V4C	60.4W - 206.09 BTU/hr	143.4W - 489.3 BTU/hr	-	-
M4350-40X4C	98.8W - 337.12 BTU/hr	200.4W - 683.79 BTU/hr	413W - 1409.21 BTU/hr	2018.3W - 6886.89BTU/hr

Environmental Specifications

Operating:

Temperature (non-PoE models)	32° to 122°F (0° to 50°C)	M4350-8X8F (XSM4316); M4350-12X12F (XSM4324); M4350-24F4V (XSM4328FV); M4350-32F8V (XSM4340FV); M4350-16V4C (VSM4320C)
Temperature (PoE models)	32° to 113°F (0° to 45°C)	M4350-24G4XF (GSM4328); M4350-48G4XF (GSM4352); M4350-44M4X4V (MSM4352); M4350-24X4V (XSM4328CV); M4350-36X4V (XSM4340CV); M4350-24X8F8V (XSM4340V)
Humidity	90% maximum relative humidity, non-condensing	
Altitude	10,000 ft (3,000 m) maximum	
Storage:		
Temperature	- 4° to 158°F (-20° to 70°C)	
Humidity	95% maximum relative humidity, non-condensing	
Altitude	10,000 ft (3,000 m) maximum	

Technical Specifications

Electromagnetic Emissions and Immunity	
Certifications	CE: EN 55032:2012+AC:2013/CISPR 32:2012, EN 61000-3-2:2014, Class A, EN 61000-3-3:2013, EN 55024:2010 VCCI : VCCI-CISPR 32:2016, Class A RCM: AS/NZS CISPR 32:2013 Class A CCC: GB4943.1-2011; YD/T993-1998; GB/T9254-2008 (Class A) FCC: 47 CFR FCC Part 15, Class A, ANSI C63.4:2014 ISED: ICES-003:2016 Issue 6, Class A, ANSI C63.4:2014 BSMI: CNS 13438 Class A
Safety	
Certifications	CB report / certificate IEC 60950-1:2005 (ed.2)+A1:2009+A2:2013 UL listed (UL 1950)/cUL IEC 950/EN 60950 CE LVD: EN 60950-1: 2006 + A11:2009 + A1:2010 + A12:2011 + A2:2013 RCM (AS/NZS) 60950.1:2015 CCC (China Compulsory Certificate): GB4943.1-2011; YD/T993-1998; GB/T9254-2008 (Class A) BSMI: CNS 14336-1
Package Content	
M4350 half-width models	Switch Power cord(s) USB Type-C to USB-A 2.0 console cable Rubber caps for the SFP+ sockets Rubber footpads for tabletop installation Installation guide 1-Switch rackmounting standard brackets 1-Switch longer brackets for recessed mounting 2-Switch pairing kit for two half-width M4350 switches in a single rack space
M4350-8X8F (XSM4316); M4350-12X12F (XSM4324)	
All rackmount other M4350 models	
M4350-24G4XF (GSM4328); M4350-48G4XF (GSM4352); M4350-44M4X4V (MSM4352); M4350-24X4V (XSM4328CV); M4350-24F4V (XSM4328FV); M4350-36X4V (XSM4340CV); M4350-24X8F8V (XSM4340V); M4350-32F8V (XSM4340FV); M4350-16V4C (VSM4320C)	Switch Power cord(s) USB Type-C to USB-A 2.0 console cable Rubber caps for the SFP+/SFP28/QSP28 sockets Rubber footpads for tabletop installation Installation guide Rackmounting standard brackets Longer brackets for recessed mounting

Technical Specifications

Optional Modules and Accessories

AGM731F	1000BASE-SX SFP LC Transceiver (multimode, 550m OM4/OM3 50/125µm, 275m OM2/OM1 62.5/125µm)	AGM731F
AGM732F	1000BASE-LX SFP LC Transceiver (single mode, 10km 9/125µm)	AGM732F
AGM734	1000BASE-T SFP RJ45 Transceiver	AGM734-10000S
AXC761	10G Direct Attach SFP+ to SFP+ 1 Meter Passive DAC Cable	AXC761-10000S
AXC763	10G Direct Attach SFP+ to SFP+ 3 Meter Passive DAC Cable	AXC763-10000S
AXC765	10G Direct Attach SFP+ to SFP+ 5 Meter Active DAC Cable	AXC765-10000S
AXC767	10G Direct Attach SFP+ to SFP+ 7 Meter Active DAC Cable	AXC767-10000S
AXC7610	10G Direct Attach SFP+ to SFP+ 10 Meter Active DAC Cable	AXC7610-10000S
AXC7615	10G Direct Attach SFP+ to SFP+ 15 Meter Fiber DAC Cable	AXC7615-10000S
AXC7620	10G Direct Attach SFP+ to SFP+ 20 Meter Fiber DAC Cable	AXC7620-10000S
AXM761	10GBASE-SR SFP+ LC Transceiver (multimode, 300m OM4/OM3 50/125µm, 33m OM2/OM1 62.5/125µm)	AXM761-10000S
AXM761 (pack of 10)	Pack of 10 AXM761 Transceivers (multimode, 300m OM4/OM3 50/125µm, 33m OM2/OM1 62.5/125µm)	AXM761P10-10000S
AXM762	10GBASE-LR SFP+ LC Transceiver (single mode, 10km 9/125µm)	AXM762-10000S
AXM762 (pack of 10)	Pack of 10 AXM762 Transceivers (single mode, 10km 9/125µm)	AXM762P10-10000S
AXM763	10GBASE-LRM SFP+ LC Transceiver (multimode, 165m OM4/OM3 50/125µm, 100m OM2/OM1 62.5/125µm)	AXM763-10000S
AXM764	10GBASE-LR LITE SFP+ LC Transceiver (single mode, 2km 9/125µm)	AXM764-10000S
AXM765	10GBASE-T SFP+ RJ45 Transceiver (80m)	AXM765-20000S

Warranty and Support

ProSAFE Limited Lifetime Hardware Warranty**	Included, lifetime
90 days of Technical Support via phone and email*	Included, 90 days after purchase
Lifetime Technical Support through online chat	Included, lifetime
Lifetime Next Business Day hardware replacement	Included, lifetime

Technical Specifications

ProSupport Service Packs							
Supplemental support contracts for:	M4350-24G4XF	M4350-48G4XF	M4350-44M4X4V	M4350-8X8F	M4350-12X12F	M4350-24X4V	M4350-24F4V
PMB0313-10000S	OnCall 24x7 1-year CAT 3						
PMB0333-10000S	OnCall 24x7 3-year CAT 3						
PMB0353-10000S	OnCall 24x7 5-year CAT 3						
Supplemental support contracts for:	M4350-36X4V	M4350-24X8F8V	M4350-32F8V	M4350-16V4C	M4350-40X4C		
PMB0314-10000S	OnCall 24x7 1-year CAT 4						
PMB0334-10000S	OnCall 24x7 3-year CAT 4						
PMB0354-10000S	OnCall 24x7 5-year CAT 4						

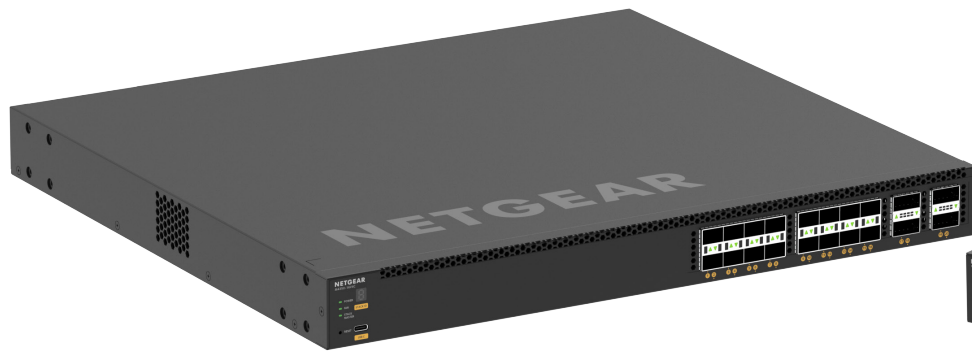

Ordering Information

NETGEAR M4350-24G4XF Fully Managed Switch (GSM4328) - 24x1G PoE+ and 4xSFP+ (648W base, up to 720W)		
North America; Europe		GSM4328-100NES (NA, UK, EU)
Asia Pacific		GSM4328-100AJS (JP, AU)
Asia Pacific		GSM4328-100PRS (CCC)
NETGEAR M4350-48G4XF Fully Managed Switch (GSM4352) - 48x1G PoE+ and 4xSFP+ (236W base, up to 1,440W)		
North America; Europe		GSM4352-100NES (NA, UK, EU)
Asia Pacific		GSM4352-100AJS (JP, AU)
Asia Pacific		GSM4352-100PRS (CCC)
NETGEAR M4350-44M4X4V Fully Managed Switch (MSM4352) - 44x2.5G, 4x10G/Multi-Gig PoE++ and 4xSFP28 25G (194W base, up to 3,314W)		
North America; Europe		MSM4352-100NES (NA, UK, EU)
North America; TAA Compliant		MSM4352-TAANES (NA, UK, EU)
Asia Pacific		MSM4352-100AJS (JP, AU)
Asia Pacific		MSM4352-100PRS (CCC)
NETGEAR M4350-8X8F Fully Managed Switch (XSM4316) - 8x10G/Multi-Gig and 8xSFP+		
North America; Europe		XSM4316-100NES (NA, UK, EU)
Asia Pacific		XSM4316-100AJS (JP, AU)
Asia Pacific		XSM4316-100PRS (CCC)
NETGEAR M4350-12X12F Fully Managed Switch (XSM4324) - 12x10G/Multi-Gig and 12xSFP+		
North America; Europe		XSM4324-100NES (NA, UK, EU)
Asia Pacific		XSM4324-100AJS (JP, AU)
Asia Pacific		XSM4324-100PRS (CCC)
NETGEAR M4350-24X4V Fully Managed Switch (XSM4328CV) - 24x10G/Multi-Gig PoE+ and 4xSFP28 25G (576W base, up to 720W)		
North America; Europe		XSM4328CV-100NES (NA, UK, EU)
North America; TAA Compliant		XSM4328CV-TAANES (NA, UK, EU)
Asia Pacific		XSM4328CV-100AJS (JP, AU)
Asia Pacific		XSM4328CV-100PRS (CCC)
NETGEAR M4350-24F4V Fully Managed Switch (XSM4328FV) - 24xSFP+ and 4xSFP28 25G		
North America; Europe		XSM4328FV-100NES (NA, UK, EU)
Asia Pacific		XSM4328FV-100AJS (JP, AU)
Asia Pacific		XSM4328FV-100PRS (CCC)



GSM4328



GSM4352



MSM4352



XSM4316



XSM4324



XSM4328CV



XSM4328FV

Ordering Information

NETGEAR M4350-36X4V Fully Managed Switch (XSM4340CV) - 36x10G/Multi-Gig PoE++ and 4xSFP28 25G (280W base, up to 1,760W)	
North America; Europe	XSM4340CV-100NES (NA, UK, EU)
Asia Pacific	XSM4340CV-100AJS (JP, AU)
Asia Pacific	XSM4340CV-100PRS (CCC)
NETGEAR M4350-24X8F8V Fully Managed Switch (XSM4340V) - 24x10G/Multi-Gig PoE++, 8xSFP+ and 8xSFP28 25G (290W base, up to 1,770W)	
North America; Europe	XSM4340V-100NES (NA, UK, EU)
North America; TAA Compliant	XSM4340V-TAANES (NA, UK, EU)
Asia Pacific	XSM4340V-100AJS (JP, AU)
Asia Pacific	XSM4340V-100PRS (CCC)
NETGEAR M4350-32F8V Fully Managed Switch (XSM4340FV) - 32xSFP+ and 8xSFP28 25G	
North America; Europe	XSM4340FV-100NES (NA, UK, EU)
North America; TAA Compliant	XSM4340FV-TAANES (NA, UK, EU)
Asia Pacific	XSM4340FV-100AJS (JP, AU)
Asia Pacific	XSM4340FV-100PRS (CCC)
NETGEAR M4350-16V4C Fully Managed Switch (VSM4320C) - 16xSFP28 25G and 4xQSFP28 100G	
North America; Europe	VSM4320C-100NES (NA, UK, EU)
North America; TAA Compliant	VSM4320C-TAANES (NA, UK, EU)
Asia Pacific	VSM4320C-100AJS (JP, AU)
Asia Pacific	VSM4320C-100PRS (CCC)
NETGEAR M4350-40X4C Fully Managed Switch (XSM4344C) - 40x10G/Multi-Gig PoE++ and 4xQSFP28 100G (196W base, up to 1,676W)	
North America; Europe	XSM4344C-100NES (NA, UK, EU)
North America; TAA Compliant	XSM4344C-TAANES (NA, UK, EU)
Asia Pacific	XSM4344C-100AJS (JP, AU)
Asia Pacific	XSM4344C-100PRS (CCC)
NETGEAR APS350W - 350W Power Supply Unit for M4350-24G4XF (GSM4328); M4350-48G4XF (GSM4352); M4350-44M4X4V (MSM4352); M4350-24X4V (XSM4328CV); M4350-24F4V (XSM4328FV)	
North America; Europe	APS350W-100NES (NA, UK, EU)
Asia Pacific	APS350W-100AJS (JP, AU)
Asia Pacific	APS350W-10000S (no power cords)
NETGEAR APS600Wv2 - 600W Power Supply Unit for M4350-24G4XF (GSM4328); M4350-48G4XF (GSM4352); M4350-44M4X4V (MSM4352); M4350-24X4V (XSM4328CV); M4350-24F4V (XSM4328FV)	
North America; Europe	APS600W-200NES (NA, UK, EU)
Asia Pacific	APS600W-200AJS (JP, AU)
Asia Pacific	APS600W-20000S (no power cords)



XSM4340CV



XSM4340V



XSM4340FV



VSM4320C



XSM4344C

- M4350-24G4XF (GSM4328)
- M4350-48G4XF (GSM4352)
- M4350-44M4X4V (MSM4352)
- M4350-24X4V (XSM4328CV)
- M4350-24F4V (XSM4328FV)

Ordering Information

NETGEAR APS920W - 920W Power Supply Unit for M4350-24G4XF (GSM4328); M4350-48G4XF (GSM4352); M4350-44M4X4V (MSM4352); M4350-24X4V (XSM4328CV); M4350-24F4V (XSM4328FV)		
North America; Europe	APS920W-100NES (NA, UK, EU)	
Asia Pacific	APS920W-100AJS (JP, AU)	M4350-24G4XF (GSM4328)
Asia Pacific	APS920W-10000S (no power cords)	M4350-48G4XF (GSM4352)
		M4350-44M4X4V (MSM4352)
		M4350-24X4V (XSM4328CV)
		M4350-24F4V (XSM4328FV)
NETGEAR APS2000W - 2000W Power Supply Unit for M4350-24G4XF (GSM4328); M4350-48G4XF (GSM4352); M4350-44M4X4V (MSM4352); M4350-24X4V (XSM4328CV); M4350-24F4V (XSM4328FV)		
North America; Europe	APS2000W-100NES (NA, UK, EU)	
Asia Pacific	APS2000W-100AJS (JP, AU)	
Asia Pacific	APS2000W-10000S (no power cords)	
NETGEAR APS600Wv3 - 600W Power Supply Unit for M4350-36X4V (XSM4340CV); M4350-24X8F8V (XSM4340V); M4350-32F8V (XSM4340FV); M4350-16V4C (VSM4320C); M4350-40X4C (XSM4344C)		
North America; Europe	APS600W-300NES (NA, UK, EU)	
Asia Pacific	APS600W-300AJS (JP, AU)	
Asia Pacific	APS600W-30000S (no power cords)	
NETGEAR APS1200Wv2 - 1200W Power Supply Unit for M4350-36X4V (XSM4340CV); M4350-24X8F8V (XSM4340V); M4350-32F8V (XSM4340FV); M4350-16V4C (VSM4320C); M4350-40X4C (XSM4344C)		M4350-36X4V (XSM4340CV)
North America; Europe	APS1200W-200NES (NA, UK, EU)	M4350-24X8F8V (XSM4340V)
Asia Pacific	APS1200W-200AJS (JP, AU)	M4350-32F8V (XSM4340FV)
Asia Pacific	APS1200W-20000S (no power cords)	M4350-16V4C (VSM4320C)
		M4350-40X4C (XSM4344C)
NETGEAR APS2000Wv2 - 2000W Power Supply Unit for M4350-36X4V (XSM4340CV); M4350-24X8F8V (XSM4340V); M4350-32F8V (XSM4340FV); M4350-16V4C (VSM4320C); M4350-40X4C (XSM4344C)		
North America; Europe	APS2000W-200NES (NA, UK, EU)	
Asia Pacific	APS2000W-200AJS (JP, AU)	
Asia Pacific	APS2000W-20000S (no power cords)	

** This product comes with a limited warranty that is valid only if purchased from a NETGEAR authorized reseller, and covers unmodified hardware, fans and internal power supplies - not software or external power supplies, and requires product registration at <https://www.netgear.com/business/registration> within 90 days of purchase; see <https://www.netgear.com/about/warranty> for details. Intended for indoor use only.

NETGEAR, the NETGEAR Logo and ProSAFE are trademarks of NETGEAR, Inc. in the United States and/or other countries. Other brand names mentioned herein are for identification purposes only and may be trademarks of their respective holder(s). Information is subject to change without notice. © 2023 NETGEAR, Inc. All rights reserved.

NETGEAR, Inc. 350 E. Plumeria Drive, San Jose, CA 95134-1911 USA, 1-888-NETGEAR (638-4327), E-mail: info@NETGEAR.com, www.NETGEAR.com

DS-M4350-20Dec24